



[www.colehersee.com.au](http://www.colehersee.com.au)

Cole Hersee



 **Cole Hersee**<sup>®</sup>  
A Littelfuse<sup>®</sup> Brand



## History - Manufacturing switches since 1924

Cole Hersee have been manufacturing reliable electrical switches for vehicles for close to 90 years, and throughout history have been recognised for innovative products. Some innovative switches have been awarded patents. Many of the electrical and electronic switches and connectors made today are specified by OEMs, or used as high-quality replacement parts.

Although 1924 is taken as the date Cole Hersee was established, antecedents go back even further to the dawn of the automobile age: The Henry Cole Company of Boston was founded in 1914!

Cole Hersee are a leading manufacturer of electromechanical, electronic and digital switches and connectors, designing dependable products for a broad range of vehicles. Since its founding in 1924, Cole Hersee has been a pioneer and leader in the development of heavy-duty electrical products for the vehicle industry, and has earned a reputation for quality and value.

Cole Hersee collaborated on many basic industry standards and today is a preferred supplier of over 2,000 dependable vehicle products and accessories. Cole Hersee is ISO 9001:2008 certified. Cole Hersee was acquired by Littelfuse, Inc. in 2010.





## Partnership - Cole Hersee is proudly supplied across Australia by ESG Asia Pacific

**ESG Asia Pacific are currently, and have been, the exclusive Australian distributor of Cole Hersee for over twenty years!**

ESG has also played a pivotal role in developing partnership products including the 'Australian Mining Regulations Standards' stamped 75910 battery master switch.

Along with Cole Hersee, ESG Asia Pacific also distributes other well-known automotive brands including ECCO, Code 3, Britax and Xray Vision.

ESG Asia Pacific is part of the ECCO Safety Group which globally serves more than 3,000 OEM and aftermarket customers.





## It's not how much you save, it's what and who you save

What would happen if you couldn't shut off the power in an emergency? What would happen if the power was accidentally switched on while someone was working on a machine? What would happen if you couldn't securely lock off your machinery—only to have it then damaged, vandalised, or stolen?

## Beware of inferior and copy products

Cheap copy components can cause expensive damage to equipment and put lives at risk. Cole Hersee products are renowned for quality and reliability that will protect you, your workers, and your valuable vehicles and equipment.



## Genuine Cole Hersee 75910 Battery Master Switch

Only genuine stamped Cole Hersee 75910 battery master switches are designed and built to not only withstand harsh mining environments, but also to ensure that when the switch is on or off, it stays on or off—without any chance of it being accidentally switched or deliberately tampered with.

This battery master switch was developed by ESG in conjunction with Cole Hersee and major mining corporations, to service specific safety requirements.

Part of the mining corporations design requirement was an extended actuation point to prevent accidental actuation even when a lockout lever is in use.

The Cole Hersee 75910 is now specified and required for all vehicles entering most major mine sites.

For more features and specifications on this switch please see page 8.

**Cole Hersee 75904 with a standard 4° actuation point**

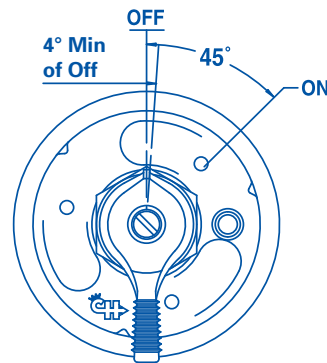

**Cole Hersee 75910 with an extended 17° actuation point**

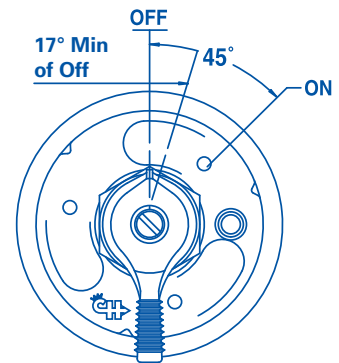

## 'Complies With Australian Mining Regulations Standards' stamp

Make sure the switch you're using is stamped with the official Cole Hersee insignia, and if it's a genuine 75910 it will have 'Complies with Australian mining regulations standards' etched

into the housing. If it doesn't have the etching, you don't have the genuine switch that is specified and required on many major mining sites.

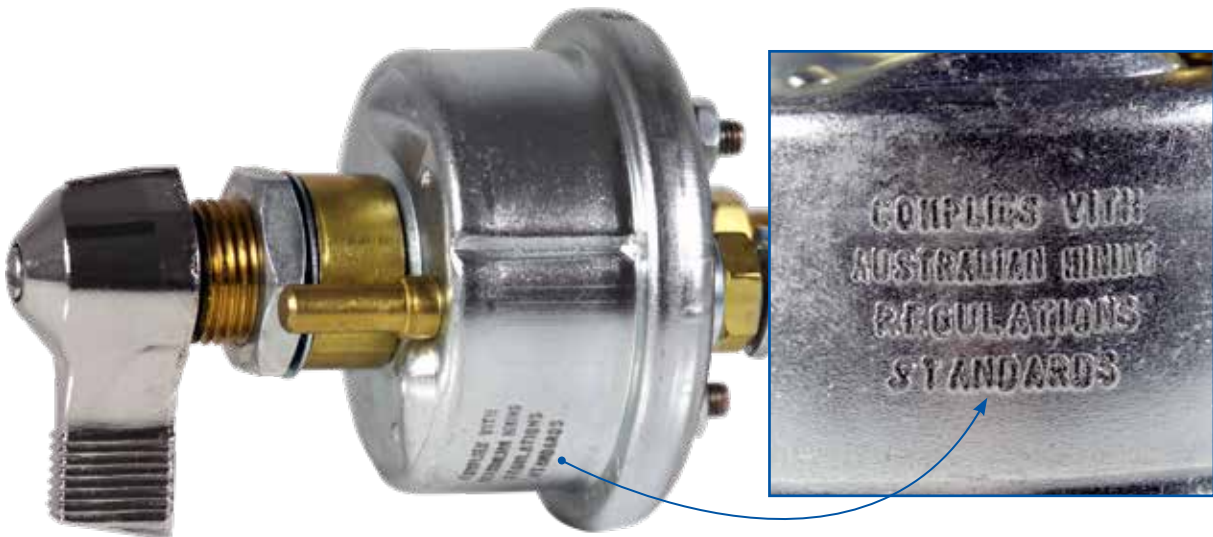

## Battery Master Switches

Page 8

For over forty years Cole Hersee has been designing and building heavy duty battery master switches that have been installed as OE equipment by leading manufacturers of heavy duty vehicles.

Battery master switches shut down a vehicle's electrical system by cutting off current from the battery. They are designed to help prevent tampering, theft, battery drain and electrical fires.

Battery master switches are available with brass or plated steel cases and are actuated by lever or hencol key. Contacts are either silver or copper. O-rings feature in the operating shaft of some models for additional moisture and dirt protection.



## Rocker Switches

Page 16

Rocker switches are manufactured in many different variations to handle most vehicle and equipment applications and are usually classified by the number of poles and throws to identify their basic operation.

Rocker switches can be either snap-in or bracket mounting, actuators can be illuminated or imprinted, contain pilot lights, or have both pilot lights and imprinting.



## Toggle Switches

Page 32

Toggle switches are manufactured in many different variations to handle most vehicle and equipment applications. Toggle switches are usually classified by the number of poles and throws to identify their basic operation.

Cole Hersee Toggle switches are available with ball, short or long handles, paddle or illuminated actuators. Housings are either plastic, plastic and metal combined, or die-cast metal.



## Push Button Switches

Page 40

Push Button switches (sometimes referred to as momentary switches) are most commonly used for Off/Mom On ignition type applications.

Cole Hersee Push Button switches are available in die-cast alloy or brass housing with most featuring chrome plated button and face nut or rubber capping.



## Rotary Switches

Page 44

Rotary switches are usually used for special purpose applications including headlamp and windscreen wiper operation. The Cole Hersee range features models which can be used for more common applications.

Cole Hersee Rotary switches are available in die-cast alloy or nylon housing with most featuring a nylon knob to fit in with your existing vehicle interior.



## Ignition Switches

Page 48

Ignition switches are operated by a coded key and tumbler lock, hencol keyed lock or lever. Lever design is available in three different configurations: short, long and military. Ignition switches are available with coded cylinder locks and keys or hencol non-tumbler locks with compatible keys.

Switches are available with a grounded case design with a separate ground terminal. A grounded case switch must be installed in a metal panel which is part of the vehicle earthing system.



## Solenoids

Page 52

A solenoid is an electromagnetic relay used in a direct current wiring system between a low current capacity switch and a high current load requirement.

In an engine starting system, the ignition switch in the start position may have a rating of 5 amps whilst the starter motor may have a cranking requirement of 200 to 350 amps.

Once energised by the ignition switch, the solenoid coil moves the high current capacity contact to a closed position, thereby energising the starter motor.



## Circuit Breakers

Page 60

Cole Hersee circuit breakers are designed and engineered for responsive performance over a long period. Casings are manufactured from either high quality plated steel or durable plastic. Cole Hersee circuit breakers are designed and engineered for responsive performance over a long product life.

All Cole Hersee circuit breakers conform to SAE Standard J553.



## Connectors and Electrical

Page 64

The Cole Hersee range includes high quality connectors and electrical equipment such as heavy duty trailer connectors, battery studs and jumpers, headlight connectors and electronic units.

Cole Hersee trailer connectors are built to withstand the rigors of trucking thousands of kilometers in dust and dirt, heat and cold, yet maintain the all-important electrical continuity between vehicle and trailer.



## Battery Master Switches

For over forty years Cole Hersee has been designing and building heavy duty battery master switches that have been installed as OE equipment by leading manufacturers of heavy duty vehicles.

Battery master switches shut down a vehicle's electrical system by cutting off current from the battery. They are designed to help prevent tampering, theft, battery drain and electrical fires.

Battery master switches are available with brass or plated steel cases and are actuated by lever or hencol key. Contacts are either silver or copper. O-rings feature in the operating shaft of some models for additional moisture and dirt protection.



### DPST On/Off Battery and Field Master Silver

**75910BX**

Australia's most reliable Battery Master Switch was developed by Cole Hersee in conjunction with ESG and major mining corporations, to service a specific requirement. The Cole Hersee 75910 is now spec'd in for all vehicles entering most major mine sites.

Brass mounting stem and studs

Chrome-plated die-cast alloy lever

Brass indexing pin prevents rotation

Strong steel plated casing

'Complies With Australian Mining Regulations Standards' stamp

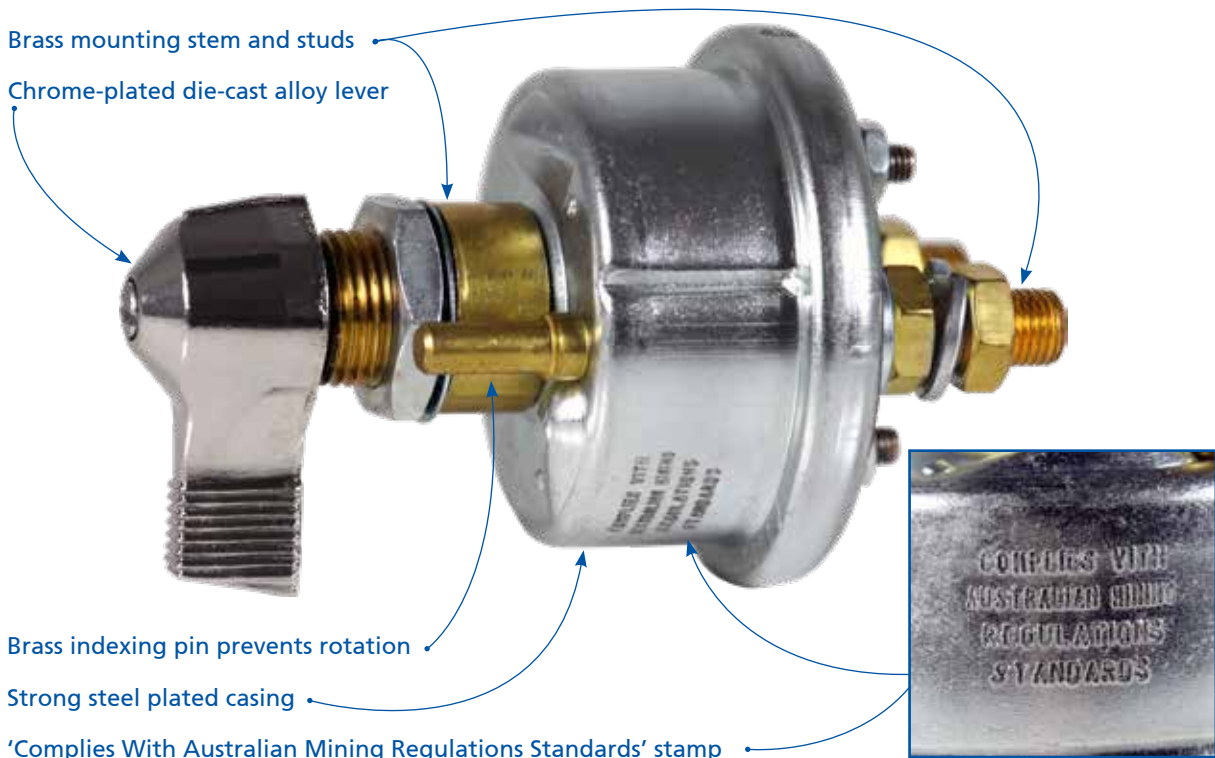

#### Features

- Silver contacts, chrome lever
- Weather resistant, O-ring sealed

#### Specifications

- Voltage . . . . 6V-36V Multivoltage
- Amperage . . . 1000A Int, 125A Cont

#### Part Numbers

75910BX . . . . . Boxed



## Battery Master Switches Selection Guide



Part Number	24024	75903	75904	75907	75910	75912	75920	75920-01	880175
Battery Inputs	1	2	2	2	2	2	1	1	2
Switch Positions	2	2	2	2	2	2	2	2	2
Alternator Field Disconnect (AFD)	No	Yes	Yes	Yes	Yes	No	No	No	No
Make Before Break Contact	No	Yes	Yes	Yes	Yes	No	N/A	N/A	No
Maximum Operating Voltage	36V DC	36V DC	36V DC	36V DC	36V DC	36V DC	36V DC	36V DC	48V DC
Continuous Rating (studs)	175A	Large: 175A Small: 20A	Large: 175A Small: 20A	Large: 300A Small: 20A	Large: 125A Small: 20A	2 X 125A	400A	400A	500A
Intermittent Rating (5 min)	400A	1000A	400A	1000A/20A	800A/20A	2x 750A	400A	400A	1000A
Cranking Rating (30 sec)	N/R	1000A	1000A min	1000A/20A min.	800A/20A min	750A each min.	2,000A	2,000A	2,250A
Inrush Rating	400A	1000A	1000A	1000A/20	1000A/20	2x 1000A	2,000A	2,000A	3,000A (1 sec)
Cable Size required to Meet Ratings	1/0	2/0	2/0	4/0	2/0	2/0	4/0	4/0	4/0
Temperature Range	-40 to +85°C	-40 to +85°C	-40 to +85°C	-40 to +85°C	-40 to +85°C	-40 to +85°C	-40 to +85°C	-40 to +85°C	-50 to +85°C
Terminal Stud Size	3/8"-24	3/4"-16	3/4"-16	3/4"-16	3/4"-16	3/4"-16	3/4"-16	3/4"-16	M12
Terminal Stud Length	0.690" (17.5mm)	0.690" (17.5mm)	0.690" (17.5mm)	0.690" (17.5mm)	0.690" (17.5mm)	0.690" (17.5mm)	3/4" (19mm)	3/4" (19mm)	0.984" (25mm)
Maximum Terminal Stud Torque	8-10 Nm	8-10 Nm	8-10 Nm	8-10 Nm	8-10 Nm	8-10 Nm	8 Nm	8 Nm	30 Nm
Terminal Stud Material	Brass	Copper	Brass	Copper	Brass	Brass	Tin-Plated Copper	Tin-Plated Copper	Tin-Plated Copper
Lock Out/Tag Out	with 24505 kit	with 24505 kit	with 24505 kit	with 24505 kit	with 24505 kit	with 24505 kit	Yes	Yes	Yes
Actuator	2 Prong Key	Chrome Lever	Chrome Lever	Diecast Lever	Chrome Lever	Chrome Lever	Red Knob	Yellow Knob	Black Knob
Ignition Protected	No	No	No	No	No	No	No	No	SAE J11 & ISO 8846
Ingress Protection	IP55	IP55	IP55	IP64	IP64	IP64	IP68	IP68	IP67 & IP69K
Mounting Stem	3/4"-16	3/4"-16	3/4"-16	3/4"-16	3/4"-16	3/4"-16	3/4"-16	3/4"-16	N/A
Anti-Rotation Pin	Yes	No	No	Yes	Yes	Yes	Yes	Yes	-

## DPST On/Off Battery Master Switch Lockout Kits

**75910CBX**

This Cole Hersee master switch will disconnect the battery and the alternator or generator field circuit.

The 75910 Cole Hersee battery master switch is the Australian approved switch by major mining corporations.

For piece of mind use a Cole Hersee lockout lever kit and flange plate that can accept a padlock to securely lock a Disconnect Switch in the Off position.

### Features

- DPST, Silver contacts, chrome lever
- Weather resistant, O-ring sealed
- Field terminals 20A continuous
- Indexing pin aligns switch and prevents rotation
- 2 x Field stud 10-32
- 2 x Battery stud 3/8"-24
- Mounting stem 3/4"-24 thread, L 13mm
- Suits panel thickness to 6.5mm
- Accepts padlocks up to 6mm diameter

### Specifications

- Voltage . . . . . 6V-36V Multivoltage
- Amperage . . . . . 1000A Intermittent, 125A Continuous, Small: 20A Cont
- Dimensions . . . H 110 x Ø 67
- Configuration . DPST
- Modes . . . . . On/Off
- Application . . . Heavy Duty, Mining

### Kit Part Numbers

- 75910CBX . . . . . Chrome Lockout Kit
- 75910RBX . . . . . Red Lockout Kit
- 75910YBX . . . . . Yellow Lockout Kit

### Lever Part Numbers

- 24505-01B . . . . . Chrome Lever
- 24505-01RB . . . . Red Lever
- 24505-01YB . . . . Yellow Lever



## SPST On/Off ABS Body Battery Master Switch

**75920BX**

### Features

- Strong black ABS body
- Silver laminated contacts
- Built-in security locking
- Indexing pin aligns switch and prevents rotation
- O-ring seal on mounting shaft
- Red or yellow locking actuator handle
- 2 x Battery studs 3/8"-24
- Mounting stem 3/4"-16 thread, L 22mm
- Suits panel thickness 12mm
- Approvals: IP68, SAE, J1455

### Specifications

- Voltage . . . . . 6V-36V Multivoltage
- Amperage . . . . . 300A Continuous, 1000A to 3000A Intermittent
- Dimensions . . . H 136 x D 86 W 70
- Configuration . SPST
- Modes . . . . . On/Off
- Application . . . Heavy Duty, Mining

### Part Numbers

- 75920BX . . . . . Red Handle
- 75920-01BX . . . . Yellow Handle



## DPST On/Off ABS Body Battery Master Switch

**880175BX**

This dual pole 500A Master Switch cuts all battery power from vehicle electrical systems with applications needing switching of two circuits, or both positive and negative.

### Features

- 2 x Battery studs 3/8"-24
- Terminal stud size: M12 x 25mm.
- Temperature range: -50° to 85°C, DC-Rated to 105°C
- Shock: 30G, Vibration: 8 G
- Ingress rating: IP67 & IP69K

### Specifications

- Voltage . . . . . 6V-48V Multivoltage
- Amperage . . . . . 500A Continuous, with 2 x 4/0 input and 2 x 4/0 output cables
- Dimensions . . . H 85 x D 103 W 120
- Configuration . DPST
- Modes . . . . . On/Off

### Part Numbers

- 880175BX . . . . . Boxed



## Battery and Field Master Switch DPST On/Off

**75907BX**

This battery and field master switch will disconnect the battery and the alternator or generator field circuit.

### Features

- Battery and field master switching
- Silver contacts, chrome lever
- Weather resistant, O-ring sealed
- Field terminals 20A continuous
- Indexing pin aligns switch and prevents rotation
- 2 x Field stud 10-32
- 2 x Battery stud 3/8"-24
- Mounting stem 3/4"-24 thread, L 13mm
- Suits panel thickness to 6.5mm

### Specifications

- Voltage . . . . . 6V-36V Multivoltage
- Amperage . . . . . 2000A Intermittent, 300A Continuous, Small: 20A Cont
- Dimensions . . . H 110 x Ø 67
- Configuration . DPST
- Modes . . . . . On/Off
- Application . . . Heavy Duty, Mining

### Part Numbers

75907BX . . . . . Boxed

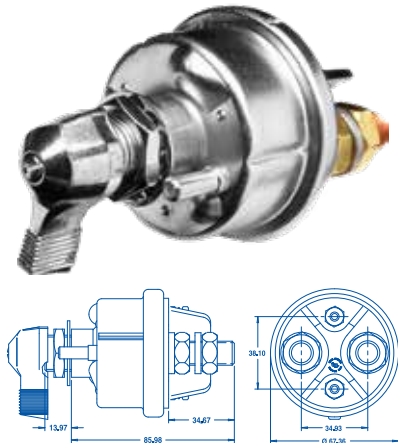

## Battery and Field Master Silver DPST On/Off

**75904BX**

This battery and field master switch will disconnect the battery and the alternator or generator field circuit.

### Features

- Battery and field master switching
- Silver contacts, chrome lever
- Weather resistant, O-ring sealed
- Field terminals 20A continuous
- Indexing pin aligns switch and prevents rotation (key start only)
- 2 x Field stud 10-32
- 2 x Battery stud 3/8"-24
- Mounting stem 3/4"-24 thread, L 13mm
- Suits panel thickness to 6.5mm

### Specifications

- Voltage . . . . . 6V-36V Multivoltage
- Amperage . . . . . 1000A Intermittent, 125A Continuous, Small: 20A Cont
- Dimensions . . . H 91 x Ø 67
- Configuration . DPST
- Modes . . . . . On/Off
- Application . . . Heavy Duty, Mining

### Part Numbers

75904BX . . . . . Lever switch  
75904-03BX . . . Key start switch



## Battery and Field Master Copper DPST On/Off

**75903BX**

This battery and field master switch will disconnect the battery and the alternator or generator field circuit.

### Features

- Battery and field master switching
- Copper contacts, chrome lever
- Weather resistant
- Field terminals 20A continuous
- 2 x Field stud 10-32
- 2 x Battery stud 3/8"-24
- Mounting stem 3/4"-24 thread, L 13mm
- Suits panel thickness to 6.5mm

### Specifications

- Voltage . . . . . 6V-36V Multivoltage
- Amperage . . . . . 1000A Intermittent, 125A Continuous, Small: 20A Cont
- Dimensions . . . H 110 x Ø 67
- Configuration . DPST
- Modes . . . . . On/Off

### Part Numbers

75903BX . . . . . Boxed

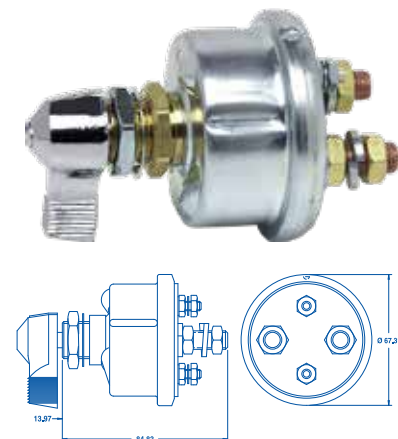

## Dual Battery Master Switch 4 Main Studs DPST

75912BX

This switch can be used to switch positive and negative at the same time, or for two separate circuits.

### Features

- Suitable for two high current loads
- Silver contacts, chrome lever
- Weather resistant, O-ring sealed
- Battery 4 x stud 3/8"-24 studs
- Indexing pin aligns switch and prevents rotation
- Mounting stem 3/4"-24 thread, L 13mm
- Suits panel thickness to 6.5mm

### Specifications

- Voltage . . . . . 6V-36V Multivoltage
- Amperage . . . . . 750A Intermittent x 2, 125A Continuous x 2
- Dimensions . . . H 110 x Ø 67
- Configuration . DPST
- Modes . . . . . On/Off
- Application . . . Heavy Duty, Mining

### Part Numbers

75912BX . . . . . Boxed

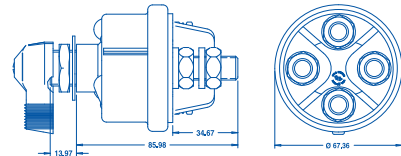

## Marine Battery Master Switch DPST On/Off

M290-05BX



This marine battery master switch will disconnect the battery preventing drain.

### Features

- Silver laminating contacts
- Brass case, chrome lever
- Field term 20A continuous
- 2 stud terminals 10-32
- Mounting stem 3/4"-24 thread
- Mounting stem length 46mm
- Suits panel thickness up to 23mm
- UL rating 707B

### Specifications

- Voltage . . . . . 6V-36V Multivoltage
- Amperage . . . . . 800A Intermittent, 125A Continuous, Small: 20A Cont
- Dimensions . . . H 86 x Ø 67
- Configuration . DPST
- Modes . . . . . On/Off
- Application . . . Heavy Duty, Marine

### Part Numbers

M290-05BX . . . . . Boxed

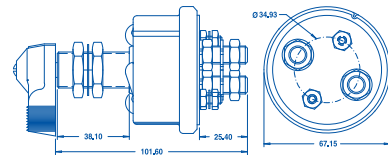

## CAT OEM Battery Master SPST On/Off Key

24024BX

CAT OEM switch replace 7N0718

### Features

- Two prong key type
- Silver laminated contacts, chrome lever
- Weather resistant O-ring sealed
- Indexing pin aligns switch and prevents rotation
- 2 stud terminals 10-32
- Mounting stem 3/4"-24 thread, L 13.5mm
- Suits panel thickness 6.5mm to 19mm

### Specifications

- Voltage . . . . . 6V-36V Multivoltage
- Amperage . . . . . 1000A Intermittent, 125A Continuous
- Dimensions . . . H 86 x Ø 67
- Configuration . SPST
- Modes . . . . . On/Off
- Application . . . Heavy Duty, Mining

### Part Numbers

24024BX . . . . . Boxed





# M750 Series

## Battery Selector and Disconnect Switches

In a dual battery system, one battery is used for starting the engine while the other is used to power auxiliary loads. A battery selector switch enables the use of the first battery, the second battery or both batteries simultaneously.

A dual battery system with a battery selector switch provides backup starting power in an emergency. One application is to put two batteries together (in parallel) to start the engine in cold weather. If the primary battery is not at full power, then the second battery can be used. This assures the availability of adequate power for starting. It also enables the user to select either battery for charging.

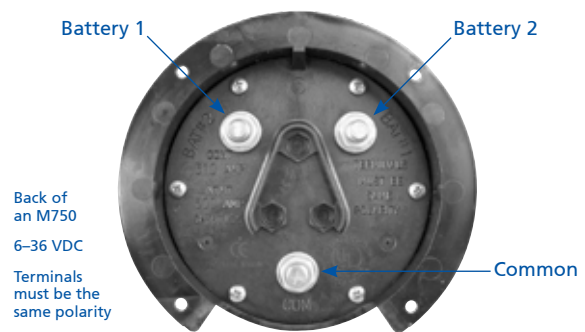
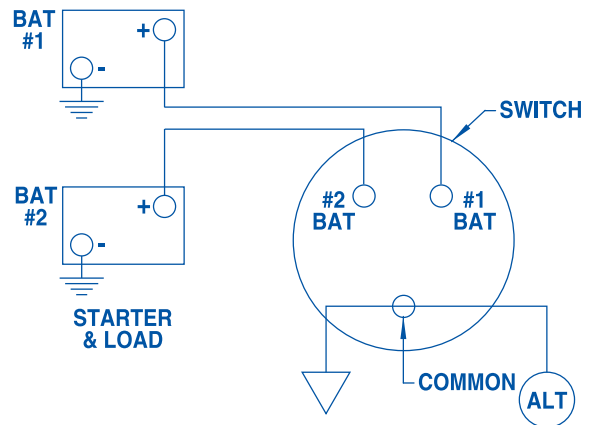

It will provide battery disconnect, protection against electrical fire, tampering, theft and battery drain when the vehicle, equipment or boat is unattended.

When using a dual battery charger it is necessary to separate the batteries while the charger is operating. The batteries must be independent of each other for the dual battery charger to operate properly. The selector switch must be turned to the OFF position to avoid damage to the charger.

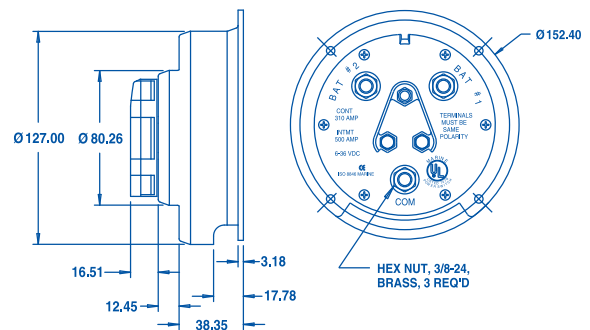

## Dual Battery Switch Selector And Disconnect

M750



This dual battery selector/master disconnect switch will suit any vehicle that needs to use two batteries where one battery is used for starting the engine, while the other is used to power auxiliary loads. UL rating 707B.

This is a common situation in trucks, boats, RVs, police and rescue vehicles, and in ambulances and fire equipment.

### Features

- High impact and plastic case and knob
- High temperature engineered plastic
- 4 Position dual battery control
- Heavy duty copper stud terminals 3/8

### Specifications

- Voltage . . . . . 6V-36V Multivoltage
- Amperage . . . . . 500A Intermittent, 310A Continuous
- Dimensions . . . . . H 67 x Ø 127
- Modes . . . . . 1: Batteries OFF  
2: Battery #1 ON  
3: Battery #1&2 ON  
4: Battery #2 ON
- Application . . . . . Heavy Duty

### Part Numbers

M750 . . . . . Clam blister



## Dual Battery Key Switch Select Disconnect

M751



This dual battery selector/master disconnect switch will suit any vehicle that needs to use two batteries where one battery is used for starting the engine, while the other is used to power auxiliary loads. UL rating 707B.

This is a common situation in trucks, boats, RVs, police and rescue vehicles, and in ambulances and fire equipment.

### Features

- High impact and plastic case and knob
- High temperature engineered plastic
- 4 Position dual battery control
- Heavy duty copper stud terminals 3/8

### Specifications

- Voltage . . . . . 6V-36V Multivoltage
- Amperage . . . . . 500A Intermittent, 310A Continuous
- Dimensions . . . . . H 67 x Ø 127
- Modes . . . . . 1: Batteries OFF  
2: Battery #1 ON  
3: Battery #1&2 ON  
4: Battery #2 ON
- Application . . . . . Heavy Duty

### Part Numbers

M751 . . . . . Clam blister



## Dual Battery Switch Selector And Alt Field

M752



This dual battery selector/master disconnect switch will suit any vehicle that needs to use two batteries where one battery is used for starting the engine, while the other is used to power auxiliary loads. UL rating 707B.

Alternator field disconnect circuit switch prevents possible alternator diode failure if the switch is accidentally turned to Off with the engines running.

### Features

- High impact and plastic case and knob
- High temperature engineered plastic
- 4 Position dual battery control
- Heavy duty copper stud terminals 3/8

### Specifications

- Voltage . . . . . 6V-36V Multivoltage
- Amperage . . . . . 500A Intermittent, 310A Continuous
- Dimensions . . . . . H 67 x Ø 127
- Modes . . . . . 1: Batteries OFF  
2: Battery #1 ON  
3: Battery #1&2 ON  
4: Battery #2 ON
- Application . . . . . Heavy Duty

### Part Numbers

M752 . . . . . Clam blister



## Rocker and Toggle Switches



Toggle and rocker switches are manufactured in many different variations to handle most vehicle and equipment applications. Toggle and rocker switches are usually classified by the number of poles and throws to identify their basic operation.

Toggle switches are available with ball, short or long handles, paddle or illuminated actuators. Housings are either plastic, plastic and metal combined, or die-cast metal.

Rocker switches can be either snap-in or bracket mounting, actuators can be illuminated or imprinted, contain pilot lights, or have both pilot lights and imprinting. Housings are usually plastic, however some models feature plastic with a metal bezel or mounting bracket.

Cole Hersee toggle and rocker switches can be used in 6, 12, 24 and 36 volt systems, and are rated up to 35 amp inductive load and 25 amp lamp load at 12 volts.

They can be used in applications such as signalling and marker lamps, windshield wiper systems, fuel selector valves, heater systems, headlight systems, and more.

Amperage requirements differ from application to application. Clearance and marker lamps on a 12 volt truck system for example, can require from less than one to just over two amps to operate. Other applications may require anywhere from five to eight amps.

When switches are turned ON or OFF, they must handle more current or voltage than is required to operate in a steady state—Cole Hersee switches are built to handle these requirements.

### Weather Resistant Features

A PVC (Polyvinyl Chloride) coating is applied to the switch body for effective sealing and protection from moisture, dirt and the elements. PVC coated switches usually come with wire leads that permit complete covering and insulation of the terminals.

Neoprene seals (O-rings) within the mounting stem protect against moisture and dirt from entering around the base of the actuator handle.

Also available are protective durable Silicone Rubber Boots that fit over the toggle handles and fasten securely to the mounting stem, making the toggle switch adaptable for use where moisture, dirt and similar elements are present.

Available in two styles: one covers the entire toggle handle (81264), the other allows the handle to protrude (81255).



### Part Numbers

81264BX . . . . . Grey	81264-04BX . . . Green
81264-01BX . . . Black	81264-05BX . . . Red
81264-02BX . . . Blue	81264-07BX . . . Yellow
81264-03BX . . . Clear	81255BX . . . . . Grey half



# Rocker and Toggle Switch Capabilities

## Single Pole (SP)

A switch that opens, closes or changes connection of a single conductor in an electrical circuit.

## Double Pole (DP)

A switch that opens, closes or changes connection of two conductors in an electrical circuit.

## Single Throw (ST)

A switch that opens, closes or completes a circuit at only one of the extreme positions of its actuator.

## Double Throw (DT)

A switch that opens, closes or completes a circuit at both extreme positions of its actuator.

Note: "Pole" should not be confused with "Terminal". The DPST switch, for example has four terminals however is a Double Pole (DP) and not a four pole (4P) switch.

### SPST On/Off

Switch controls a single wire circuit.



### SPDT On/On and SPDT On/Off/On

Switch controls two single wire circuits, permitting only one circuit to be energised at a time.

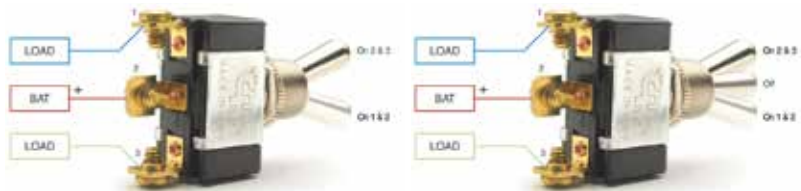

### DPST On/Off

Switch controls two single wire circuits, permitting only one circuit to be energised at a time.



### DPDT On/On and DPDT On/Off/On

Switch controls two circuits, permitting only two circuits to be energised at a time.



# Rocker Switch Mounting Accessories

## Bezels for Mounting Switches Side by Side

For snap-in mounting of any regular size switch such as 58312 and 58328 series. Bezels can be arranged in a parallel array of any length.

Bezels themselves can snap into a panel, or be mounted with the Bracket Mounting Kit.



### Part Numbers

98628BX . . . . . Blank      82159-3BX . . . . . End  
82159-2BX . . . . . Centre      82159-1BX . . . . . Single

## Snap-together Bracket Mounting Kit

For installing an array of switches onto a panel, when through mounting isn't possible. Use in conjunction with 82159 bezels.

Holds from 2 to 6 bezels. Snap-together assembly. Kit contains two bracket sections and brass stabilizing rods.

Kit brackets engage with bezels. Brass rods snap into brackets to stabilize the unit.



### Part Numbers

87167-01BX . . . . . Boxed

# 58312 Series

## Sealed Rocker Switches with LED Pilot Lights

The 58312 Series switches feature modern LED technology which gives a wide illumination angle, low power consumption and long service life meaning no globes to change. IP66 rated.

With silver contacts for superior switching performance, and modern rounded edges and actuators, these matte finish switches fit perfectly into any modern vehicle or machine.



### SPST On/Off Dependent LED Rocker Switch

#### 58312-A4BX

The 58312 Series switches feature modern LED technology which gives a wide illumination angle, low power consumption and long service life.

#### Features

- Dependent operation, on with load
- 3 Blade terminals, silver contacts
- Wide bezel black, snap in mounting
- Weather resistant IP66 sealed
- Fits panel 2.4mm – 4.7mm
- Panel hole: W 21.1mm, H 36.8mm

#### Specifications

- Voltage . . . . 12V
- Amperage . . . . 25A@12V
- Dimensions . . . H 44 x D 41 x W 25

#### Part Numbers

- 58312-A4BX . . . Amber
- 58312-C4BX . . . Clear
- 58312-G4BX . . . Green
- 58312-R4BX . . . Red

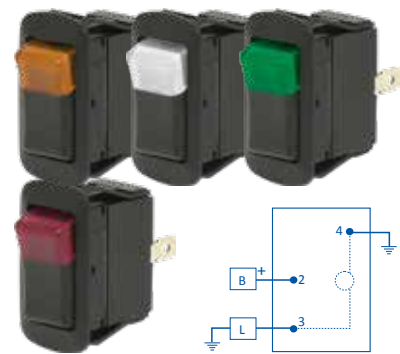

### SPST On/Off Independent LED Rocker Switch

#### 58312-A2BX

The 58312 Series switches feature modern LED technology which gives a wide illumination angle, low power consumption and long service life.

#### Features

- Independent pilot with Switch or Load
- 4 Blade terminals, silver contacts
- Wide bezel black, snap in mounting
- Weather resistant IP66 sealed
- Fits panel 2.4mm – 4.7mm
- Panel hole: W 21.1mm, H 36.8mm

#### Specifications

- Voltage . . . . 12V
- Amperage . . . . 25A@12V
- Dimensions . . . H 44 x D 41 x W 25

#### Part Numbers

- 58312-A2BX . . . Amber
- 58312-G2BX . . . Green
- 58312-R2BX . . . Red

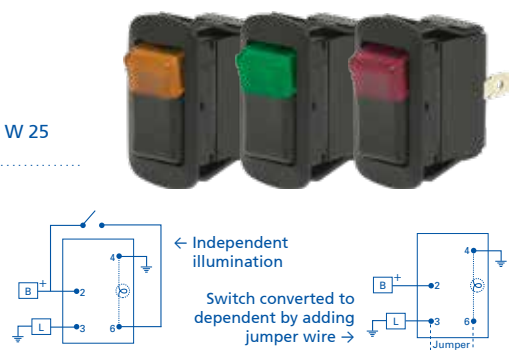

### SPDT On/On Dependent LED Rocker Switch

#### 58312-RG2BX

The 58312 Series switches feature modern LED technology which gives a wide illumination angle, low power consumption and long service life.

#### Features

- Dependent operation, on with load
- 4 Blade terminals, silver contacts
- Wide bezel black, snap in mounting
- Weather resistant IP66 sealed
- Fits panel 2.4mm – 4.7mm
- Panel hole: W 21.1mm, H 36.8mm

#### Specifications

- Voltage . . . . 12V
- Amperage . . . . 25A@12V
- Dimensions . . . H 44 x D 41 x W 25

#### Part Numbers

- 58312-RG2BX . . . Red/Green
- 58312-RRBX . . . Red/Red

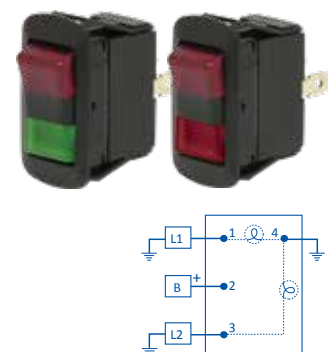

# Illumination

## Dependent Vs Independent



Dependent illumination means the lamp in the switch is powered by the load.

Therefore, when the switch is off, the lamp is off. When the switch is on, the lamp is illuminated.

This makes it easy to see when the load is active. These switches are also available as ON/ON and ON/OFF/ON with dual dependent illumination.

## Independent + Dependent Illumination



Independent illumination means that a separate electrical signal or switch powers the lamp, regardless of what function the switch is performing at any one time.

For example, the independent lamp might be wired to the dash lights of a vehicle to make the switch visible in the dark. Or it could be used as a driving light switch with the independent lamp signaling when the headlights are active.

The independent + dependent switches enable a pilot light to be illuminated and an additional lamp to be illuminated when the switch is actuated.

## SPDT On/Off/On Dependent LED Rocker Switch

### 58312-AGBX

The 58312 Series switches feature modern LED technology which gives a wide illumination angle, low power consumption and long service life.

#### Features

- Dependent LED's x 2, ON with Load
- 4 Blade terminals, silver contacts
- Wide bezel black, snap in mounting
- Weather resistant IP66 sealed
- Fits panel 2.4mm – 4.7mm
- Panel hole: W 21.1mm, H 36.8mm

#### Specifications

- Voltage . . . . 12V
- Amperage . . . 25A@12V
- Dimensions . . H 44 x D 41 x W 25

#### Part Numbers

- 58312-AGBX . . . Amber/Green
- 58312-ARBX . . . Amber/Red
- 58312-RCBX . . . Red/Clear
- 58312-RGBX . . . Red/Green
- 58312-RRBX . . . Red/Red

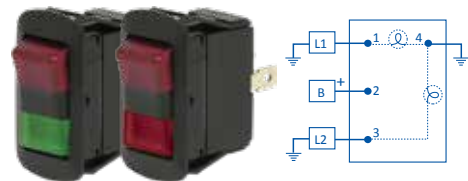

## SPST On/Off Dependent + Independent LED Rocker

### 58312-GA4BX

The 58312 Series switches feature modern LED technology which gives a wide illumination angle, low power consumption and long service life.

#### Features

- Dependent LED + Independent LED, Switched or with Load
- 4 Blade terminals, silver contacts
- Wide bezel black, snap in mounting
- Fits panel 2.4mm – 4.7mm
- Panel hole: W 21.1mm, H 36.8mm

#### Specifications

- Voltage . . . . 12V
- Amperage . . . 25A@12V
- Dimensions . . H 44 x D 41 x W 25

#### Part Numbers

- 58312-GA4BX . . . Amber/Green
- 58312-RG4BX . . . Red/Green
- 58312-RR4BX . . . Red/Red

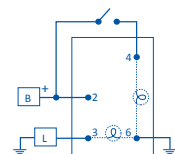

## SPST On/Off Dependent Pilot Rocker Switch

**58328-13BX**

Rocker switches are manufactured in many different variations to handle most vehicle and equipment applications and are usually classified by the number of poles and throws to identify their basic operation.

### Features

- Dependent pilot ON with load
- Black actuator illuminated
- 3 Blade terminals, silver contacts
- Wide bezel, snap in mounting
- Range of colour options
- Fits panel 2.36mm – 4.73mm
- Panel hole: W 21.1mm, H 36.8mm

### Specifications

- Voltage . . . . . 12V or 24V
- Amperage . . . . . 25A@12V
- Dimensions . . . H 43 x D 41 x W 24
- Configuration . . . SPST
- Modes . . . . . On/Off

### Part Numbers

- 58328-04BX . . . Red 12V
- 58328-11BX . . . Green 12V
- 58328-12BX . . . Clear 12V
- 58328-13BX . . . Amber 12V
- 58328-55BX . . . Blue 12V
- 58328-58BX . . . Red 24V
- 58328-62BX . . . Amber 24V



## SPST On/Off Dependent Pilot Rocker Switch

**58328-100BX**

These kits come with a selection of snap-in lenses to customise or change the colour combinations.

### Features

- Dependent pilot ON with load
- Black actuator illuminated
- 3 Blade terminals, silver contacts
- Wide bezel, snap in mounting
- 4 Coloured lenses supplied
- Fits panel 2.36mm – 4.73mm
- Panel hole: W 21.1mm, H 36.8mm

### Specifications

- Voltage . . . . . 12V
- Amperage . . . . . 25A@12V
- Dimensions . . . H 43 x D 41 x W 24
- Configuration . . . SPST
- Modes . . . . . On/Off

### Part Numbers

- 58328-100BX. . . Boxed

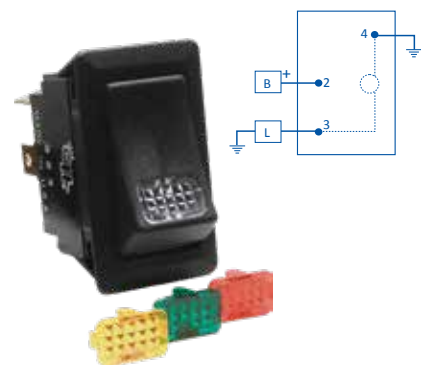

## SPST On/Off Independent Pilot Rocker Switch

**58328-101BX**

These kits come with a selection of snap-in lenses to customise or change the colour combinations.

### Features

- Independent pilot with switch or load
- Black actuator illuminated
- 4 Blade terminals, silver contacts
- Wide bezel, snap in mounting
- 4 Coloured lenses supplied
- Fits panel 2.36mm – 4.73mm
- Panel hole: W 21.1mm, H 36.8mm

### Specifications

- Voltage . . . . . 12V
- Amperage . . . . . 25A@12V
- Dimensions . . . H 43 x D 41 x W 24
- Configuration . . . SPST
- Modes . . . . . On/Off

### Part Numbers

- 58328-101BX. . . Boxed

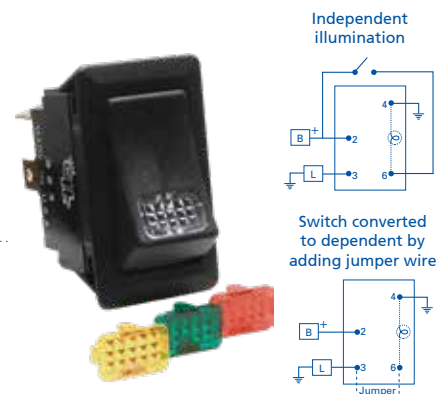

## SPDT On/On Dependent Pilot Rocker Switch

58328-102BX

These kits come with a selection of snap-in lenses to customise or change the colour combinations.

### Features

- Dependent dual pilot ON with loads
- Black actuator illuminated
- 4 Blade terminals, silver contacts
- Wide bezel, snap in mounting
- 2 x 4 Coloured lenses supplied
- Fits panel 2.36mm – 4.73mm
- Panel hole: W 21.1mm, H 36.8mm

### Specifications

- Voltage . . . . . 12V
- Amperage . . . . . 25A@12V
- Dimensions . . . H 43 x D 41 x W 24
- Configuration . SPDT
- Modes . . . . . On/On

### Part Numbers

58328-102BX. . . . . Boxed

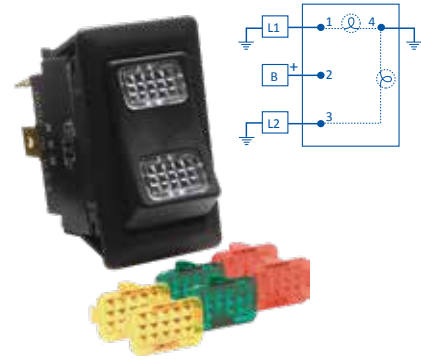

## SPDT On/Off/On Dependent Pilot Rocker Switch

58328-103BX

These kits come with a selection of snap-in lenses to customise or change the colour combinations.

### Features

- Dependent dual pilot ON with loads
- Black actuator illuminated
- 4 Blade terminals, silver contacts
- Wide bezel, snap in mounting
- 2 x 4 Coloured lenses supplied
- Fits panel 2.36mm – 4.73mm
- Panel hole: W 21.1mm, H 36.8mm

### Specifications

- Voltage . . . . . 12V
- Amperage . . . . . 25A@12V
- Dimensions . . . H 43 x D 41 x W 24
- Configuration . SPDT
- Modes . . . . . On/Off/On

### Part Numbers

58328-103BX. . . . . Boxed

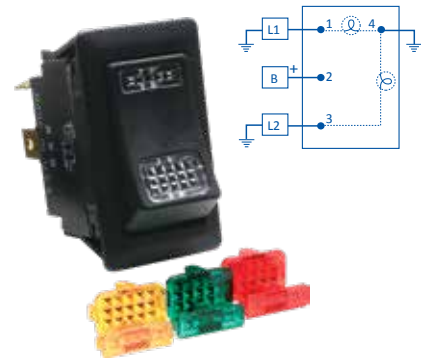

## SPST On/Off Dependent + Independent Rocker

58328-104BX

These kits come with a selection of snap-in lenses to customise or change the colour combinations.

### Features

- Dependent pilot ON with load + Independent Pilot Switch or Load
- Black actuator illuminated
- 4 Blade terminals, silver contacts
- Wide bezel, snap in mounting
- 2 x 4 Coloured lenses supplied
- Fits panel 2.36mm – 4.73mm
- Panel hole: W 21.1mm, H 36.8mm

### Specifications

- Voltage . . . . . 12V
- Amperage . . . . . 25A@12V
- Dimensions . . . H 43 x D 41 x W 24
- Configuration . SPST
- Modes . . . . . On/Off

### Part Numbers

58328-104BX. . . . . Boxed

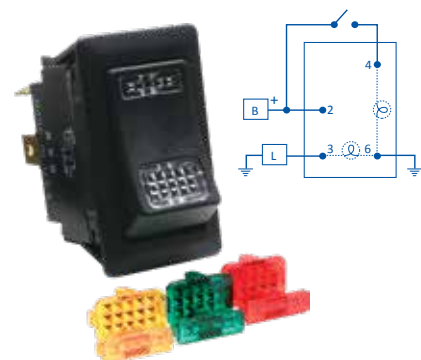

# 58326 Series

## Sealed Rocker Switches with Incandescent Pilot Lights

The Incandescent Paddle Series Rocker Switches feature imprinted automotive symbols on some models. With silver contacts for superior switching performance, these matte finish switches fit perfectly into any modern or classic vehicle or machine.



### SPST On/Off Illuminated Symbol Rocker

**58326-01BX**

#### Features

- Independent illumination, Term 7 & 8
- Sealed, blade terminals, silver contacts
- Nylon wide bezel, snap in mounting
- Supplied with neoprene panel seal
- Fits panels 2.35mm – 4.73mm
- Panel hole: W 21.1mm, H 36.8mm

#### Specifications

- Voltage . . . . 12V
- Amperage . . . . 25A@12V
- Dimensions . . . H 49 x D 39 x W 24
- Configuration . SPST
- Modes . . . . . On/Off

#### Part Numbers

- 58326-01BX . . . White Blank
- 58326-01RBX. . . Red Blank
- 58326-15BX . . . White Interior
- 58326-18BX . . . White Strobe

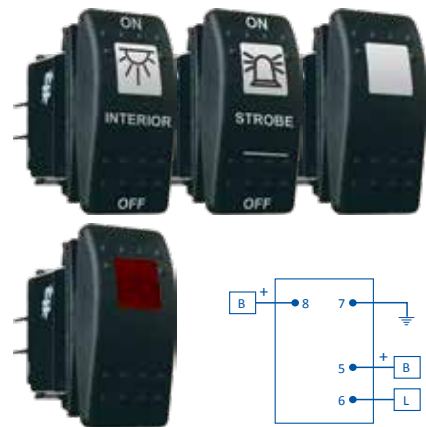

### DPDT On/Off/On Illuminated Blank Rocker

**58326-06BX**

#### Features

- Independent illumination, Term 7 & 8
- ON 1&2, 4&5> OFF > ON 2&3, 5&6
- Sealed, blade terminals, silver contacts
- Nylon wide bezel, snap in mounting
- Supplied with neoprene panel seal
- Fits panels 2.35mm – 4.73mm
- Panel hole: W 21.1mm, H 36.8mm

#### Specifications

- Voltage . . . . 12V
- Amperage . . . . 25A@12V
- Dimensions . . . H 49 x D 39 x W 24
- Configuration . DPDT
- Modes . . . . . On/Off/On

#### Part Numbers

- 58326-06BX . . . White Blank

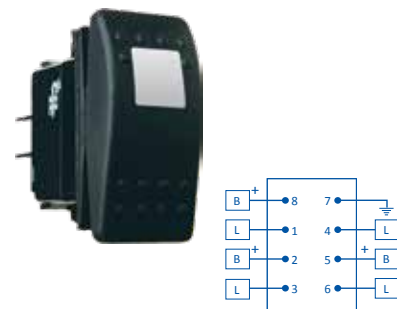

## Build Your Own Illuminated Rocker Switch - Page 16

Five handy kits, each with a set of snap-in pilot light lenses, cover all the electrical types and pilot light combinations.

- 58328-100BX** On-Off SPST, dependent
- 58328-101BX** On-Off SPST, independent
- 58328-102BX** On-On SPDT, dependent
- 58328-103BX** On-Off-On, dependent
- 58328-104BX** On-Off SPST, one dependent, one independent



## SPST Off/Mom On Illuminated Symbol Rocker

**58326-21BX**

### Features

- Independent illumination, Term 7 & 8
- Sealed, blade terminals, silver contacts
- Nylon wide bezel, snap in mounting
- Supplied with neoprene panel seal
- Fits panels 2.35mm – 4.73mm
- Panel hole: W 21.1mm, H 36.8mm

### Specifications

- Voltage . . . . . 12V
- Amperage . . . . . 25A@12V
- Dimensions . . . H 49 x D 39 x W 24
- Configuration . SPST
- Modes . . . . . Off/Mom On

### Part Numbers

58326-21BX . . . White Wash

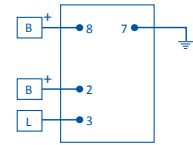

## DPDT Off/On/Mom On Illuminated Symbol

**58326-11BX**

### Features

- Independent illumination, Term 7 & 8
- SPST Off/On Term 2 & 3
- SPDT Mom On Term 5 & 6
- Sealed, blade terminals, silver contacts
- Nylon wide bezel, snap in mounting
- Supplied with neoprene panel seal
- Fits panels 2.35mm – 4.73mm
- Panel hole: W 21.1mm, H 36.8mm

### Specifications

- Voltage . . . . . 12V
- Amperage . . . . . 25A@12V
- Dimensions . . . H 49 x D 39 x W 24
- Configuration . SPST
- Modes . . . . . Off/On/Mom On

### Part Numbers

58326-11BX . . . White Warning

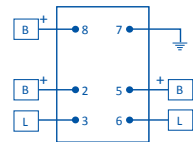

## DPTT On/On/On Illuminated Symbol Rocker

**58326-29BX**

### Features

- Independent illumination, Term 7 & 8
- ON 1&2, 4&5> ON 2&3, 4&5> ON 2&3, 5&6
- Sealed, blade terminals, silver contacts
- Nylon wide bezel, snap in mounting
- Supplied with neoprene panel seal
- Fits panels 2.35mm – 4.73mm
- Panel hole: W 21.1mm, H 36.8mm

### Specifications

- Voltage . . . . . 12V
- Amperage . . . . . 25A@12V
- Dimensions . . . H 49 x D 39 x W 24
- Configuration . DPTT
- Modes . . . . . On/On/On

### Part Numbers

58326-29BX . . . White Fan

58326-24BX . . . White Defrost

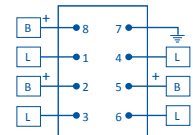

# 58311 Series

## Sealed Weather Resistant Rocker Switches IP66

The 58311 Series switches feature silver contacts for superior switching performance, and modern rounded edges and actuators, these matte finish switches fit perfectly into any modern vehicle or machine. They are also IP66 rated.



### SPST Sealed Blank Rocker Switch

### 58311-01BX

#### Features

- 2 Blade terminals, silver contacts
- Wide bezel black, snap in mounting
- Weather resistant IP66 sealed
- Dimensions H 44 x D 41 x W 25
- Fits panels 2.35mm - 4.73mm
- Panel hole: W 21.1mm, H 36.8mm

#### Specifications

- Voltage . . . . 12/24V Dualvoltage
- Amperage . . . . 25A@12V, 12A@24V

#### Part Numbers

- 58311-01BX . . . On/Off
- 58311-02BX . . . Off/Mom On

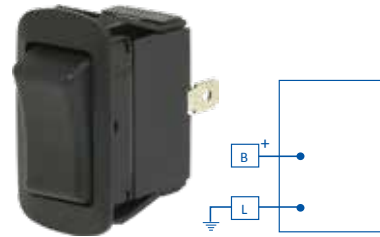

### SPDT Sealed Blank Rocker Switch

### 58311-03BX

#### Features

- 3 Blade terminals, silver contacts
- Wide bezel black, snap in mounting
- Weather resistant IP66 sealed
- Dimensions H 44 x D 41 x W 25
- Fits panels 2.35mm - 4.73mm
- Panel hole: W 21.1mm, H 36.8mm

#### Specifications

- Voltage . . . . 12/24V Dualvoltage
- Amperage . . . . 25A@12V, 12A@24V

#### Part Numbers

- 58311-03BX . . . On/Off/On
- 58311-04BX . . . Mom On/Off/Mom On

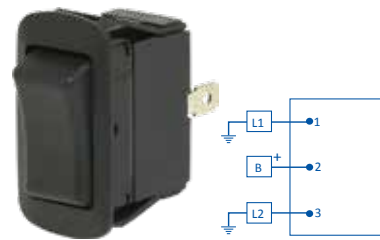

### DPST Sealed Blank Rocker Switch

### 58311-06BX

#### Features

- 4 Blade terminals, silver contacts
- Wide bezel black, snap in mounting
- Weather resistant IP66 sealed
- Dimensions H 44 x D 41 x W 25
- Fits panels 2.35mm - 4.73mm
- Panel hole: W 21.1mm, H 36.8mm

#### Specifications

- Voltage . . . . 12/24V Dualvoltage
- Amperage . . . . 25A@12V, 12A@24V

#### Part Numbers

- 58311-06BX . . . On/Off
- 58311-13BX . . . Off/Mom On

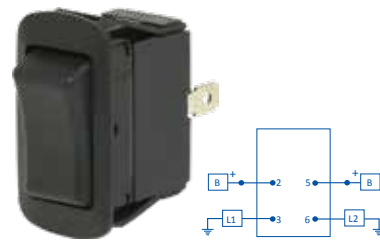



## DPST Sealed Blank Rocker Switch

**58311-07BX**

### Features

- 6 Blade terminals, silver contacts
- Wide bezel black, snap in mounting
- Weather resistant IP66 sealed
- Polarity reversing
- Dimensions H 44 x D 41 x W 25
- Fits panels 2.35mm - 4.73mm
- Panel hole: W 21.1mm, H 36.8mm

### Specifications

- Voltage . . . . 12/24V Dualvoltage
- Amperage . . . . 25A@12V, 12A@24V

### Part Numbers

- 58311-07BX . . . . On/Off/On
- 58311-08BX . . . . On/On
- 58311-11BX . . . . Mom On/Off/Mom On

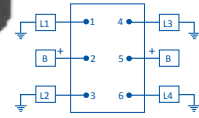

## DPDT Sealed Blank Reverse Rocker Switch

**58311-18BX**

This switch suit forward and reverse control of permanent magnet motors, momentary actuator.

### Features

- 4 Blade terminals, silver contacts
- Wide bezel black, snap in mounting
- Weather resistant IP66 sealed
- Fits panels 2.35mm - 4.73mm
- Panel hole: W 21.1mm, H 36.8mm

### Specifications

- Voltage . . . . 12/24V Dualvoltage
- Amperage . . . . 25A@12V, 12A@24V
- Dimensions . . . . H 44 x D 41 x W 25

### Part Numbers

- 58311-18BX . . . . Mom On/Off/Mom On Rev

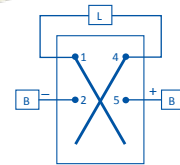

## SPST Non-Illuminated Blank Rocker Switch

**58027-01BX**

### Features

- 2 Blade terminals, silver contacts
- Narrow black bezel, snap in mounting
- Dimensions H 43 x D 41 x W 24
- Fits panels 2.35mm - 4.73mm
- Panel hole: W 21.1mm, H 36.8mm

### Specifications

- Voltage . . . . . 12/24V Dualvoltage
- Amperage . . . . . 25A@12V, 12A@24V

### Part Numbers

- 58027-01BX . . . . . On/Off
- 58027-02BX . . . . . Off/Mom On

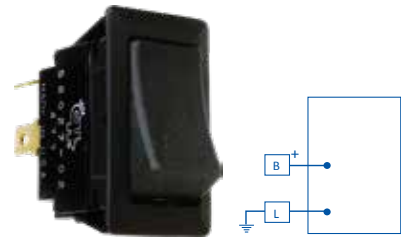

## SPST On/Off Non-Illuminated Fog Symbol Rocker

**58027-17BX**

### Features

- 2 Blade terminals, silver contacts
- Narrow black bezel, snap in mounting
- Dimensions H 43 x D 41 x W 24
- Fits panels 2.35mm - 4.73mm
- Panel hole: W 21.1mm, H 36.8mm

### Specifications

- Voltage . . . . . 12/24V Dualvoltage
- Amperage . . . . . 25A@12V, 12A@24V

### Part Numbers

- 58027-17BX . . . . . On/Off

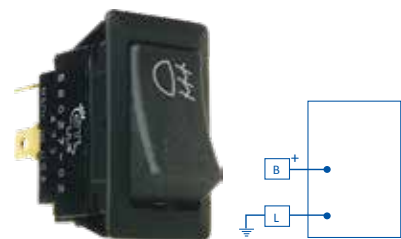

## SPDT Non-Illuminated Blank Rocker Switch

**58027-03BX**

### Features

- 3 Blade terminals, silver contacts
- Narrow black bezel, snap in mounting
- Dimensions H 43 x D 41 x W 24
- Fits panels 2.35mm - 4.73mm
- Panel hole: W 21.1mm, H 36.8mm

### Specifications

- Voltage . . . . . 12/24V Dualvoltage
- Amperage . . . . . 25A@12V, 12A@24V

### Part Numbers

- 58027-03BX . . . . . On/Off/On
- 58027-04BX . . . . . Mom On/Off/Mom On

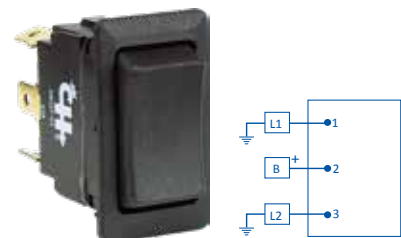

## DPST On/Off Non-Illuminated Blank Rocker

**58027-06BX**

### Features

- 4 Blade terminals, silver contacts
- Narrow black bezel, snap in mounting
- Dimensions H 43 x D 41 x W 24
- Fits panels 2.35mm - 4.73mm
- Panel hole: W 21.1mm, H 36.8mm

### Specifications

- Voltage . . . . . 12/24V Dualvoltage
- Amperage . . . . . 25A@12V, 12A@24V

### Part Numbers

- 58027-06BX . . . . . On/Off

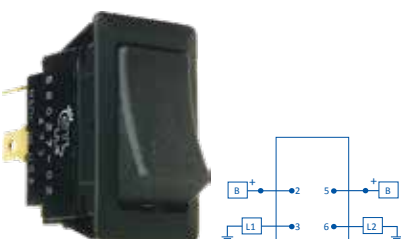

## DPDT On/Off/On Non-Illuminated Blank Rocker

**58027-07BX**

### Features

- 6 Blade terminals, silver contacts
- Narrow black bezel, snap in mounting
- Dimensions H 43 x D 41 x W 24
- Fits panels 2.35mm - 4.73mm
- Panel hole: W 21.1mm, H 36.8mm

### Specifications

- Voltage . . . . . 12/24V Dualvoltage
- Amperage . . . . . 25A@12V, 12A@24V

### Part Numbers

58027-07BX . . . . . On/Off/On

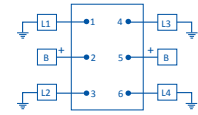

## DPDT Mom On/Off/Mom On Reversing Rocker

**58027-11BX**

### Features

- Polarity reversing
- 6 Blade terminals, silver contacts
- Narrow black bezel, snap in mounting
- Dimensions H 43 x D 41 x W 24
- Fits panels 2.35mm - 4.73mm
- Panel hole: W 21.1mm, H 36.8mm

### Specifications

- Voltage . . . . . 12/24V Dualvoltage
- Amperage . . . . . 25A@12V, 12A@24V

### Part Numbers

58027-11BX . . . . . Mom On/Off/Mom On

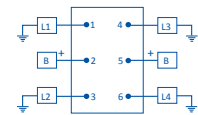

## DPDT Mom On/Off/Mom On Reversing Rocker

**58027-18BX**

This switch suit forward and reverse control of permanent magnet motors, momentary actuator.

### Features

- Forward and Reversing
- Permanent magnet
- 4 Blade terminals, silver contacts
- Wide bezel black, snap in mounting
- Fits panels 2.35mm - 4.73mm
- Panel hole: W 21.1mm, H 36.8mm

### Specifications

- Voltage . . . . . 12/24V Dualvoltage
- Amperage . . . . . 25A@12V, 12A@24V

### Part Numbers

58027-18BX . . . . . Mom On/Off/Mom On

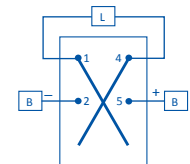

## Blank Toggle and Rocker Switch 12V, 24V, 36V Ratings

Generally, Cole Hersee heavy duty 12V non-illuminated\* toggle and rocker switches can be used at higher voltage but lower current.

Example: By calculation, 25A 12V switch will derate to 8.3A at 36V, or 12.5A at 24V.

This calculated de-rating gives a conservative result. 25A at 12V toggle switches\* can actually be used at 15A at 24V, and 10A at 36V.

\*Exception: This does not apply to illuminated switches. The pilot light must only be supplied with the stated voltage. Do not derate any illuminated switches.



## SPST On/Off Sealed Marine Blank Rocker Switch

M58031-01BX



### Features

- Water resistant, IP66 rating, UL 1500
- Supplied with neoprene panel seal
- 2 Blade terminals, silver contacts
- Wide black bezel, snap in mounting
- Fits panels 2.35mm - 4.73mm
- Panel hole: W 21.1mm, H 36.8mm

### Specifications

- Voltage . . . . . 12/24V Dualvoltage
- Amperage . . . . . 20A@12V, 10A@24V
- Dimensions . . . . . H 49 x D 39 x W 24

### Part Numbers

M58031-01BX . . . On/Off

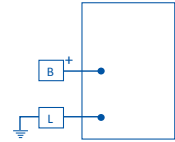

## SPST Off/Mom On Sealed Marine Blank Rocker

M58031-07BX



### Features

- Water resistant, IP66 rating, UL 1500
- Supplied with neoprene panel seal
- 2 Blade terminals, silver contacts
- Wide black bezel, snap in mounting
- Fits panels 2.35mm - 4.73mm
- Panel hole: W 21.1mm, H 36.8mm

### Specifications

- Voltage . . . . . 12/24V Dualvoltage
- Amperage . . . . . 20A@12V, 10A@24V
- Dimensions . . . . . H 49 x D 39 x W 24

### Part Numbers

M58031-07BX . . . Off/Mom On

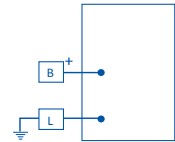

## SPDT On/Off/On Sealed Marine Blank Rocker

M58031-02BX



### Features

- Water resistant, IP66 rating, UL 1500
- Supplied with neoprene panel seal
- 3 Blade terminals, silver contacts
- Wide black bezel, snap in mounting
- Fits panels 2.35mm - 4.73mm
- Panel hole: W 21.1mm, H 36.8mm

### Specifications

- Voltage . . . . . 12/24V Dualvoltage
- Amperage . . . . . 20A@12V, 10A@24V
- Dimensions . . . . . H 49 x D 39 x W 24

### Part Numbers

M58031-02BX . . . On/Off/On

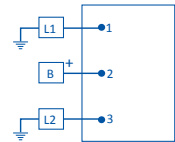

## DPST On/Off Sealed Marine Blank Rocker

M58031-04BX



### Features

- Water resistant, IP66 rating, UL 1500
- Supplied with neoprene panel seal
- 4 Blade terminals, silver contacts
- Wide black bezel, snap in mounting
- Fits panels 2.35mm - 4.73mm
- Panel hole: W 21.1mm, H 36.8mm

### Specifications

- Voltage . . . . . 12/24V Dualvoltage
- Amperage . . . . . 20A@12V, 10A@24V
- Dimensions . . . . . H 49 x D 39 x W 24

### Part Numbers

M58031-04BX . . . On/Off

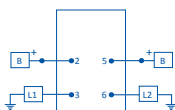

## SPST On/Off Dependent Pilot Rocker Switch

58327-01BX

### Features

- Dependent pilot ON with load
- Black actuator illuminated
- 3 Blade terminals, silver contacts
- Wide bezel, snap in mounting
- Fits panel 2.36mm – 4.73mm
- Panel hole: W 21.1mm, H 36.8mm

### Specifications

- Voltage . . . . . 12V
- Amperage . . . . . 25A@12V
- Dimensions . . . H 43 x D 38 x W 25
- Configuration . SPST
- Modes . . . . . On/Off

### Part Numbers

58327-01BX . . . . . Boxed



## SPDT On/Off/On Dependent Pilot Rocker Switch

58327-06BX

### Features

- Dependent pilot ON with load
- Black actuator illuminated
- 4 Blade terminals, silver contacts
- Wide bezel, snap in mounting
- Fits panel 2.36mm – 4.73mm
- Panel hole: W 21.1mm, H 36.8mm

### Specifications

- Voltage . . . . . 12V
- Amperage . . . . . 25A@12V
- Dimensions . . . H 43 x D 38 x W 25
- Configuration . SPDT
- Modes . . . . . On/Off/On

### Part Numbers

58327-06BX . . . . . Boxed



## SPST On/Off Locking Actuator Rocker Switch

58336BX

This rocker switch automatically locks the actuator into the Off position to help prevent accidental actuation. And must be slid to allow the actuator to be moved to the On position.

### Features

- Locking actuator, slide release  
Orange Lock on each operation
- 2 Blade terminals, silver contacts
- Fits panels 2.35mm to 4.73mm
- Panel hole: W 21.1mm, H 36.8mm

### Specifications

- Voltage . . . . . 12V or 24V
- Amperage . . . . . 25A@12V
- Dimensions . . . H 43 x D 38 x W 25
- Configuration . SPST
- Modes . . . . . On/Off

### Part Numbers

58336BX . . . . . Boxed



## SPST On/Off Illuminated Red Rocker Switch

54012BX

### Features

- 3 Blade terminals, silver contacts
- Narrow body, snap in mounting
- Dimensions H 31 x D 35 x W 17
- Fits panels thickness 1.35 - 5.15mm
- Panel hole W 14mm, H 28.6mm

### Specifications

- Voltage . . . . . 12V
- Amperage . . . . . 10A@12V

### Part Numbers

54012BX . . . . . Boxed



## Rocker Switch Mounting End Section

**82159-1BX**

### Features

- Rocker switch end panel
- Hole height 48.3mm, W 26.2mm for each section
- Accepts wide body rockers 58328, 58027, 58326, 58312 & 58311 series

### Specifications

- Dimensions . . . H 59 x D 31 x W 31

### Part Numbers

82159-1BX . . . . . Boxed

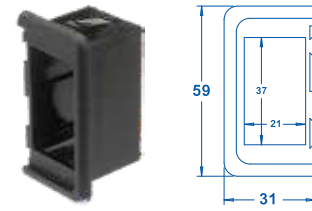

## Rocker Switch Mounting Centre Section

**82159-2BX**

### Features

- Rocker switch centre panel
- Hole height 48.3mm, W 26.2mm for each section
- Accepts wide body rockers 58328, 58027, 58326, 58312 & 58311 series

### Specifications

- Dimensions . . . H 59 x D 31 x W 27

### Part Numbers

82159-2BX . . . . . Boxed

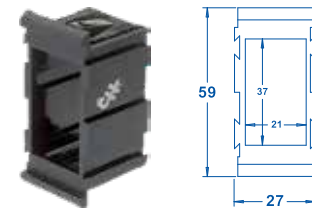

## Rocker Switch Mounting Independent Bezel

**82159-3BX**

### Features

- Rocker switch independent bezel
- Hole height 48.3mm, W 25mm
- Accepts wide body rockers 58328, 58027, 58326, 58312 & 58311 series

### Specifications

- Dimensions . . . H 48.3 x D 31 x W 25

### Part Numbers

82159-3BX . . . . . Boxed



## Rocker Switch Mounting Blank Insert Cover

**98628BX**

### Features

- Rocker blank insert
- Use with rocker switch mounting brackets 82159-1BX and 82159-2BX

### Specifications

- Dimensions . . . H 48.3 x D 31 x W 25

### Part Numbers

98628BX . . . . . Boxed



## Rocker Switch Mounting Bracket Kit Under Dash

**87167-01BX**

### Features

- Snap together holds 3-5 brackets
- Brass rods to stabilize section
- Assembled kit mounts on top of or under the dash panel
- Mounting holes 18mm x 6.7mm

### Part Numbers

87167-01BX . . . . . Boxed





## SPST On/Off Blade Terminals Toggle Switch

**55014BX**

### Features

- 2 Blade terminals, silver contacts
- Dimensions H 29 x D 60 x W 16
- Stem: thread 15/32-32, L 12mm, D 12mm
- Panel thickness: 6.35mm, Handle: 17mm

### Specifications

- Voltage . . . . . 12/24V Dualvoltage
- Amperage . . . . . 25A@12V, 12A@24V

### Part Numbers

55014BX . . . . . Boxed

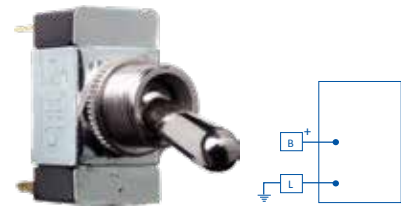

## SPST On/Off Screw Terminals Toggle Switch

**5582BX**

### Features

- 2 Screw terminals, silver contacts
- Dimensions H 29 x D 55 x W 16
- Stem: thread 15/32-32, L 12mm, D 12mm
- Panel thickness: 6.35mm, Handle: 17mm

### Specifications

- Voltage . . . . . 12/24V Dualvoltage
- Amperage . . . . . 25A@12V, 12A@24V

### Part Numbers

5582BX. . . . . Boxed

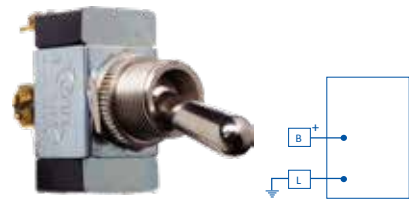

## SPST On/Off Sealed Leads Toggle Switch

**5582-10BX**

### Features

- O-ring in stem, silver contact
- Pre-wired, PVC coated housing
- Dimensions H 29 x D 55 x W 16
- Stem: thread 15/32-32, L 12mm, D 12mm
- Panel thickness: 6.35mm, Handle: 17mm

### Specifications

- Voltage . . . . . 12/24V Dualvoltage
- Amperage . . . . . 25A@12V, 12A@24V

### Part Numbers

5582-10BX . . . . . Boxed

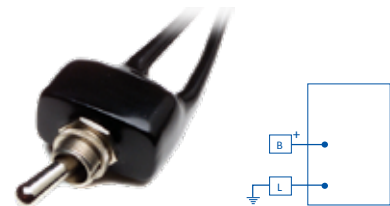

## SPDT On/On Screw Terminals Toggle Switch

**5584BX**

### Features

- 3 Screw terminals, silver contacts
- Dimensions H 29 x D 53 x W 16
- Stem: thread 15/32-32, L 12mm, D 12mm
- Panel thickness: 6.35mm, Handle: 17mm

### Specifications

- Voltage . . . . . 12/24V Dualvoltage
- Amperage . . . . . 25A@12V, 12A@24V

### Part Numbers

5584BX. . . . . Boxed



## DPDT On/Off/On Screw Terminals Toggle Switch

**5592BX**

### Features

- 6 Screw terminals, silver contacts
- Dimensions H 33 x D 48 x W 19
- Stem: thread 15/32-32, L 12mm, D 12mm
- Panel thickness: 6.35mm, Handle: 17mm

### Specifications

- Voltage . . . . . 12/24V Dualvoltage
- Amperage . . . . . 25A@12V, 12A@24V

### Part Numbers

5592BX. . . . . Boxed

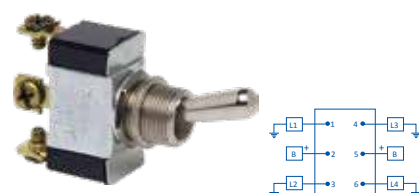



## SPDT On/On Blade Terminals Toggle Switch

**55016BX**

### Features

- 3 Blade terminals, silver contacts
- Dimensions H 29 x D 60 x W 16
- Stem: thread 15/32-32, L 12mm, D 12mm
- Panel thickness: 6.35mm, Handle: 17mm

### Specifications

- Voltage . . . . . 12/24V Dualvoltage
- Amperage . . . . . 25A@12V, 12A@24V

### Part Numbers

55016BX . . . . . Boxed

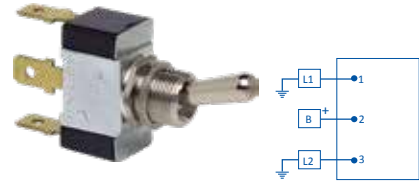

## SPDT On/Off/On Blade Terminals Toggle Switch

**5585BX**

### Features

- 3 Screw terminals, silver contacts
- Dimensions H 29 x D 55 x W 16
- Stem: thread 15/32-32, L 12mm, D 12mm
- Panel thickness: 6.35mm, Handle: 17mm

### Specifications

- Voltage . . . . . 12/24V Dualvoltage
- Amperage . . . . . 25A@12V, 12A@24V

### Part Numbers

5585BX. . . . . Boxed

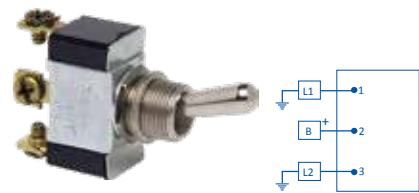

## SPDT On/Off/On Sealed Leads Toggle Switch

**M55036BX**

### Features

- O-ring in stem, silver contact
- Pre-wired, PVC coated housing
- Dimensions H 29 x D 55 x W 16
- Stem: thread 15/32-32, L 12mm, D 12mm
- Panel thickness: 6.35mm, Handle: 17mm

### Specifications

- Voltage . . . . . 12/24V Dualvoltage
- Amperage . . . . . 25A@12V, 12A@24V

### Part Numbers

M55036BX . . . . . Boxed

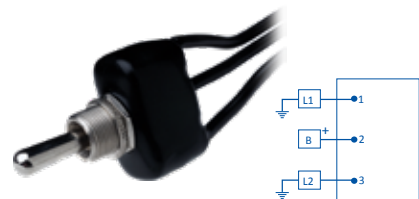

## SPST On/Off Screw Terminals Mini Toggle

**M484BX**

### Features

- 2 Brass screw terminals
- Dimensions H 32 x D 41 x W 13
- Stem: thread 15/32-32, L 12mm, D 12mm
- Panel thickness: 6.35mm, Handle: 17mm

### Specifications

- Voltage . . . . . 12/24V Dualvoltage
- Amperage . . . . . 25A@12V, 12A@24V

### Part Numbers

M484BX . . . . . Boxed



## SPST On/Off Blade Terminals Mini Toggle

**M586BX**

### Features

- 2 Blade terminals
- Dimensions H 32 x D 41 x W 13
- Stem: thread 15/32-32, L 12mm, D 12mm
- Panel thickness: 6.35mm, Handle: 17mm

### Specifications

- Voltage . . . . . 12/24V Dualvoltage
- Amperage . . . . . 25A@12V, 12A@24V

### Part Numbers

M586BX . . . . . Boxed

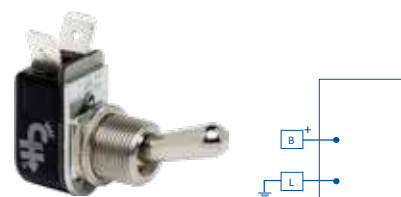

## SPST Off/Mom On Screw Terminals Toggle

55020BX

### Features

- 2 Screw terminals, silver contacts
- Dimensions H 28 x D 41 x W 16
- Stem: thread 15/32-32, L 12mm, D 12mm
- Panel thickness: 6.35mm, Handle: 17mm

### Specifications

- Voltage . . . . . 12/24V Dualvoltage
- Amperage . . . . . 25A@12V, 12A@24V

### Part Numbers

55020BX . . . . . Boxed

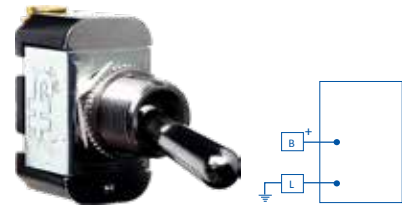

## SPDT Mom On/Off/Mom On Screw Terminals

55021BX

### Features

- 2 Screw terminals, silver contacts
- Dimensions H 34 x D 55 x W 19
- Stem: thread 15/32-32, L 12mm, D 12mm
- Panel thickness: 6.35mm, Handle: 17mm

### Specifications

- Voltage . . . . . 12/24V Dualvoltage
- Amperage . . . . . 25A@12V, 12A@24V

### Part Numbers

55021BX . . . . . Boxed

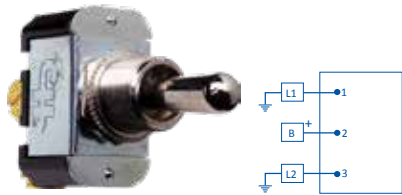

## SPDT Mom On/Off/Mom On Screw Terminals

55021-07BX

### Features

- O-ring in stem, silver contact
- Pre-wired, PVC coated housing
- Dimensions H 34 x D 55 x W 19
- Stem: thread 15/32-32, L 12mm, D 12mm
- Panel thickness: 6.35mm, Handle: 17mm

### Specifications

- Voltage . . . . . 12/24V Dualvoltage
- Amperage . . . . . 25A@12V, 12A@24V

### Part Numbers

55021-07BX . . . . . Boxed



## SPST On/Off Blade Terminals Long Handle

55055BX

### Features

- 2 Blade terminals, silver contacts
- Dimensions H 28 x D 94 x W 16
- Stem: thread 15/32-32, L 12mm, D 12mm
- Panel thickness: 6.35mm, Handle: 38mm

### Specifications

- Voltage . . . . . 12/24V Dualvoltage
- Amperage . . . . . 25A@12V, 12A@24V

### Part Numbers

55055BX . . . . . Boxed



## DPDT On/Off/On Blade Terminals Long Handle

55057BX

### Features

- 6 Blade terminals, silver contacts
- Dimensions H 34 x D 94 x W 19
- Stem: thread 15/32-32, L 12mm, D 12mm
- Panel thickness: 6.35mm, Handle: 38mm

### Specifications

- Voltage . . . . . 12/24V Dualvoltage
- Amperage . . . . . 25A@12V, 12A@24V

### Part Numbers

55057BX . . . . . Boxed



## SPST On/Off Blade Terminals Illuminated Red

**M54111-01BX**

### Features

- Clear OFF, illuminates red ON
- 4 Blade terminals, silver contacts
- Dimensions H 35 x D 56 x W 16
- Stem: thread 15/32-32, L 9mm, D 12mm
- Panel thickness: 6.35mm, Handle: 17mm

### Specifications

- Voltage . . . . 12V
- Amperage . . . . 25A@12V

### Part Numbers

M54111-01BX . . . . . Boxed



Independent Illumination

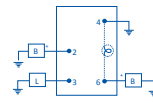

Dependent Illumination

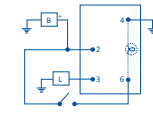

## SPDT On/Off/On Blade Terminals Illuminated Red

**M54111-02BX**

### Features

- Clear OFF, illuminates red ON
- 5 Blade terminals, silver contacts
- Dimensions H 35 x D 56 x W 16
- Stem: thread 15/32-32, L 9mm, D 12mm
- Panel thickness: 6.35mm, Handle: 17mm

### Specifications

- Voltage . . . . 12V
- Amperage . . . . 25A@12V

### Part Numbers

M54111-02BX . . . . . Boxed



Independent Illumination

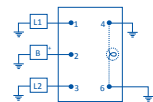

Dependent Illumination

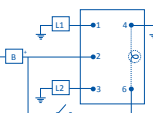

## SPDT On/Off/On Blade Terminals Illuminated Red

**54110-01BX**

### Features

- Weather resistant, O-ring seal bushing
- Clear OFF, illuminates red ON
- 5 Blade terminals, silver contacts
- Dimensions H 35 x D 61 x W 19
- Stem: thread 15/32-32, L 9mm, D 12mm
- Panel thickness: 6.35mm, Handle: 17mm

### Specifications

- Voltage . . . . 12V
- Amperage . . . . 25A@12V

### Part Numbers

54110-01BX . . . . . Boxed



Independent Illumination

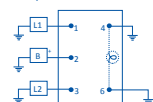

Dependent Illumination

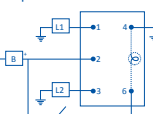

## DPDT On/Off/On Blade Long Handle Head Light

**55064BX**

### Features

- Bridged 4 circuit, headlamp switch
- 6 Blade terminals, silver contacts
- Dimensions H 34 x D 94 x W 19
- Stem: thread 15/32-32, L 12mm, D 12mm
- Panel thickness: 6.35mm, Handle: 38mm

### Specifications

- Voltage . . . . 12/24V Dualvoltage
- Amperage . . . . 25A@12V, 12A@24V

### Part Numbers

55064BX . . . . . Boxed

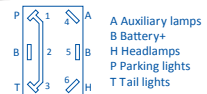

## SPDT On/On Blade Terminals Paddle Toggle

**59024-104BX**

### Features

- Paddle handle (nylon, rep 'Freightliner')
- 3 Blade terminals, silver contacts
- Dimensions H 33 x D 67 x W 19
- Stem: thread 15/32-32, L 12mm, D 12mm
- Panel thickness: 6.35mm, Handle: 25mm

### Specifications

- Voltage . . . . . 12/24V Dualvoltage
- Amperage . . . . . 25A@12V, 12A@24V

### Part Numbers

59024-104BX. . . . . Boxed



## SPDT On/Off/On Blade Terminals Paddle Toggle

**59024-13BX**

### Features

- Paddle handle (nylon, rep 'Freightliner')
- 3 Blade terminals, silver contacts
- Dimensions H 33 x D 67 x W 19
- Stem: thread 15/32-32, L 12mm, D 12mm
- Panel thickness: 6.35mm, Handle: 25mm

### Specifications

- Voltage . . . . . 12/24V Dualvoltage
- Amperage . . . . . 25A@12V, 12A@24V

### Part Numbers

59024-13BX . . . . . Boxed



## DPDT On/Off/On Blade Terminals Paddle Toggle

**59024-15BX**

### Features

- Paddle handle (nylon, rep 'Freightliner')
- 6 Blade terminals, silver contacts
- Dimensions H 33 x D 67 x W 19
- Stem: thread 15/32-32, L 12mm, D 12mm
- Panel thickness: 6.35mm, Handle: 25mm

### Specifications

- Voltage . . . . . 12/24V Dualvoltage
- Amperage . . . . . 25A@12V, 12A@24V

### Part Numbers

59024-15BX . . . . . Boxed

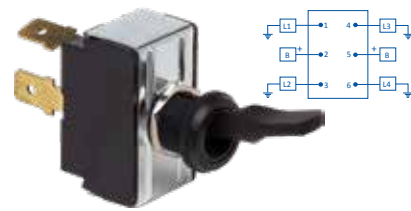

## DPDT On/Off/On Blade Terminals Toggle Switch

**55017BX**

### Features

- 4 Blade terminals, silver contacts
- Dimensions H 33 x D 44 x W 19
- Stem: thread 15/32-32, L 12mm, D 12mm
- Panel thickness: 6.35mm, Handle: 17mm

### Specifications

- Voltage . . . . . 12/24V Dualvoltage
- Amperage . . . . . 25A@12V, 12A@24V

### Part Numbers

55017BX . . . . . Boxed

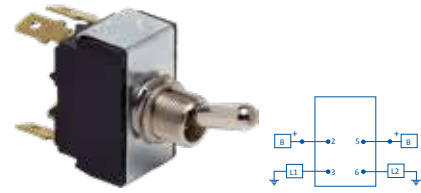

## DPDT On/On Blade Terminals Toggle Switch

**55018BX**

### Features

- 6 Blade terminals, silver contacts
- Dimensions H 34 x D 60 x W 19
- Stem: thread 15/32-32, L 12mm, D 12mm
- Panel thickness: 6.35mm, Handle: 17mm

### Specifications

- Voltage . . . . . 12/24V Dualvoltage
- Amperage . . . . . 25A@12V, 12A@24V

### Part Numbers

55018BX . . . . . Boxed

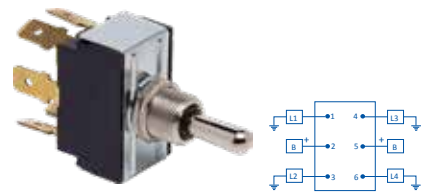

## DPDT On/Off/On Blade Terminals Toggle Switch

**55019BX**

### Features

- 6 Blade terminals, silver contacts
- Dimensions H 34 x D 60 x W 19
- Stem: thread 15/32-32, L 12mm, D 12mm
- Panel thickness: 6.35mm, Handle: 17mm

### Specifications

- Voltage . . . . . 12/24V Dualvoltage
- Amperage . . . . . 25A@12V, 12A@24V

### Part Numbers

55019BX . . . . . Boxed

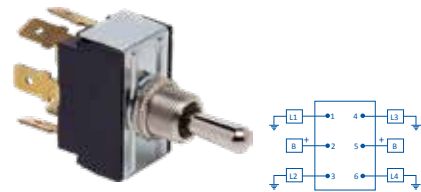

## Build Your Own Illuminated Rocker Switch - Page 16

Five handy kits, each with a set of snap-in pilot light lenses, cover all the electrical types and pilot light combinations.

**58328-100BX** On-Off SPST, dependent

**58328-101BX** On-Off SPST, independent

**58328-102BX** On-On SPDT, dependent

**58328-103BX** On-Off-On, dependent

**58328-104BX** On-Off SPST, one dependent, one independent



## Blank Toggle and Rocker Switch 12V, 24V, 36V Ratings

Generally, Cole Hersee heavy duty 12V non-illuminated\* toggle and rocker switches can be used at higher voltage but lower current.

Example: By calculation, 25A 12V switch will derate to 8.3A at 36V, or 12.5A at 24V.

This calculated de-rating gives a conservative result. 25A at 12V toggle switches\* can actually be used at 15A at 24V, and 10A at 36V.

\*Exception: This does not apply to illuminated switches. The pilot light must only be supplied with the stated voltage. Do not derate any illuminated switches.



## DPDT Mom On/Off/On Blade Terminals Reversing

**55081BX**

### Features

- Reversing polarity
- 6 Blade terminals, silver contacts
- Dimensions H 28 x D 58 x W 19
- Stem: thread 15/32-32, L 12mm, D 12mm
- Panel thickness: 6.35mm, Handle: 17mm

### Specifications

- Voltage . . . . . 12/24V Dualvoltage
- Amperage . . . . . 25A@12V, 12A@24V

### Part Numbers

55081BX . . . . . Boxed

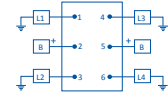

## DPDT Mom On/Off/Mom On Screw Reversing

**55054BX**

### Features

- Reversing polarity
- 6 Screw terminals, silver contacts
- Dimensions H 34 x D 58 x W 19
- Stem: thread 15/32-32, L 12mm, D 12mm
- Panel thickness: 6.35mm, Handle: 17mm

### Specifications

- Voltage . . . . . 12/24V Dualvoltage
- Amperage . . . . . 25A@12V, 12A@24V

### Part Numbers

55054BX . . . . . Boxed

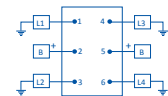

## DPDT Mom On/Off/Mom On Blade Reversing

**55065-03BX**

### Features

- Reversing polarity
- 6 Blade terminals, silver contacts
- Dimensions H 34 x D 58 x W 19
- Stem: thread 15/32-32, L 12mm, D 12mm
- Panel thickness: 6.35mm, Handle: 17mm

### Specifications

- Voltage . . . . . 12/24V Dualvoltage
- Amperage . . . . . 25A@12V, 12A@24V

### Part Numbers

55065-03BX . . . . . Boxed

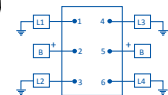

## DPDT Mom On/Off/Mom On Blade Reversing

**55065-02BX**

### Features

- Reversing polarity, long handle
- 6 Blade terminals, silver contacts
- Dimensions H 34 x D 58 x W 19
- Stem: thread 15/32-32, L 12mm, D 12mm
- Panel thickness: 6.35mm, Handle: 38mm

### Specifications

- Voltage . . . . . 12/24V Dualvoltage
- Amperage . . . . . 25A@12V, 12A@24V

### Part Numbers

55065-02BX . . . . . Boxed

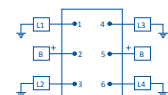

## DPDT Mom On/Off/Mom On Bridged Reversing

**55046BX**

This switch if used for changing direction of permanent magnet electric motors: fans, booms, conveyors etc.

### Features

- 4 Blade terminals, silver contacts
- Dimensions H 34 x D 69 x W 19

### Specifications

- Voltage . . . . . 12/24V Dualvoltage
- Amperage . . . . . 25A@12V, 12A@24V

### Part Numbers

55046BX . . . . . Boxed

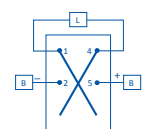

## Toggle Switch Security Cover Guard

**82468BX**

### Features

- For security of switch operation
- Spring-loaded snap action cover
- Stops accidental operation
- Rugged red melamine cover
- Suit D 12mm, Handle 18mm

### Specifications

- Dimensions . . . H 47 x D 27 x W 18

### Part Numbers

82468BX . . . . . Boxed



## Toggle Switch Guard Nickel Plated Steel

**82465BX**

### Features

- Nickel plated steel
- Stamped 'ON' 'OFF'
- Suits 15/32" 12mm diameter switches
- Side wall protection for handle

### Specifications

- Dimensions . . . H 54 x W 25

### Part Numbers

82465BX . . . . . Boxed



## Toggle Switch Faceplate Chrome Plated

**M-518BX**

### Features

- Chrome plated brass
- Stamped 'ON' 'OFF'
- Suits 15/32" 12mm diameter switches

### Specifications

- Dimensions . . . H 25 x W 16

### Part Numbers

M-518BX . . . . . Boxed



## Toggle Switch Gangplate Chrome Plated

**M-506BX**

### Features

- Chrome plated brass
- Stamped 'ON' 'OFF'
- Dimensions H 55.5
- Suits 15/32" 12mm diameter switches

### Part Numbers

M-505BX . . . . . 3 Gang, W 65mm

M-506BX . . . . . 4 Gang, W 86mm

M-507BX . . . . . 5 Gang, W 106mm

M-508BX . . . . . 6 Gang, W 127mm



## Toggle Switch Silicone Sealing Boots

**81264BX**

### Features

- Highly-durable silicone rubber
- O-ring seal with the panel
- Silicon rubber, up to 17.5mm handle
- Suits thread 15/32-32, Screw on to fit

### Part Numbers

81264BX . . . . . Grey

81264-01BX . . . . . Black

81264-02BX . . . . . Blue

81264-03BX . . . . . Clear

### Part Numbers

81264-04BX . . . . . Green

81264-05BX . . . . . Red

81264-07BX . . . . . Yellow

81255BX . . . . . Grey half



## Push Button Switches

Push Button switches (sometimes referred to as momentary switches) are most commonly used for Off/Mom On ignition type applications.

Cole Hersee Push Button switches are available in die-cast alloy or brass housing with most featuring chrome plated button and face nut or rubber capping. Some models feature a PVC coated body to help seal against moisture and dirt.



### SPST Off/Mom On START Push Button Switch

**90047BX**

#### Features

- 2 Screw terminals, silver contacts
- 'ENGINE START' imprint (black)
- 'ENGINE STOP' imprint (red)
- Embossed in white on black
- Impact resistant, repels water and oil
- Mounting hole 21mm
- Suits panel thickness 1mm to 2.5mm

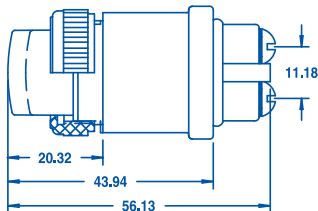

#### Specifications

- Voltage . . . . 6V-36V Multivoltage
- Amperage . . . . 35A@12V, 20A@24V
- Dimensions . . . H 56 x Ø 29
- Configuration . SPST
- Modes . . . . . Off/Mom On

#### Part Numbers

- 90047BX . . . . . Boxed (start)
- 90048BX . . . . . Boxed (stop)



### SPST Off/Mom On Screw Push Button Switch

**90030BX**

#### Features

- Spring return to OFF
- 2 Screw terminals, silver contacts
- Protective weather/dustproof cap
- Mounting stem 5/8" – 32, Length 16mm
- Suits panel thickness 6.35mm-15.87mm

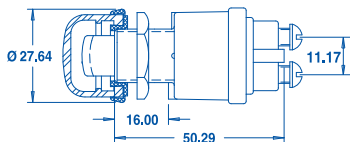

#### Specifications

- Voltage . . . . 6V-36V Multivoltage
- Amperage . . . . 35A@12V, 20A@24V
- Dimensions . . . H 60 x Ø 28
- Configuration . SPST
- Modes . . . . . Off/Mom On

#### Part Numbers

- 90030BX . . . . . Boxed





## SPST On/Mom Off Sealed Push Button Switch

**90043BX**

### Features

- Spring return to ON
- Normally ON, 2 blade terminals
- 2 Screw terminals (with lock washers)
- Mounting stem 5/8"-32, Length 22.3mm
- Suits panel thickness 12.7mm

### Specifications

- Voltage . . . . . 6V-36V Multivoltage
- Amperage . . . . . 10A@12V, 5A@24V
- Dimensions . . . H 33 x D 62 x W 29

### Part Numbers

90043BX . . . . . Boxed

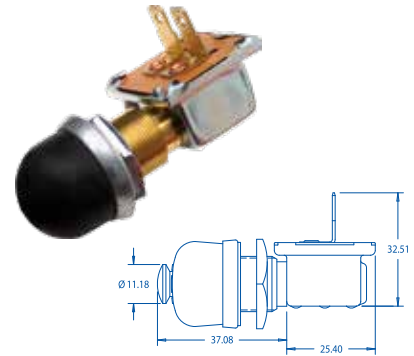

## SPST On/Mom Off Sealed Push Button Switch

**90043-07BX**

### Features

- Spring return to ON
- Normally ON, steel plunger
- Pre-wired PVC coated body
- Mounting stem 5/8"-32, Length 16mm
- Suits panel thickness 12.7mm

### Specifications

- Voltage . . . . . 6V-36V Multivoltage
- Amperage . . . . . 20A@12V, 10A@24V
- Dimensions . . . H 33 x D 62 x W 29

### Part Numbers

90043-07BX . . . . . Boxed



## SPST Off/Mom On Sealed Push Button Switch

**M608BX**

### Features

- Spring return to OFF
- Pre-wired PVC coated housing
- Copper alloy contacts, brass body
- Mounting stem 5/8"-32", L 24mm
- Suits panel thickness 12.70mm

### Specifications

- Voltage . . . . . 6V-36V Multivoltage
- Amperage . . . . . 10A@12V, 5A@24V
- Dimensions . . . H 33 x D 62 x W 29

### Part Numbers

M608BX . . . . . Boxed

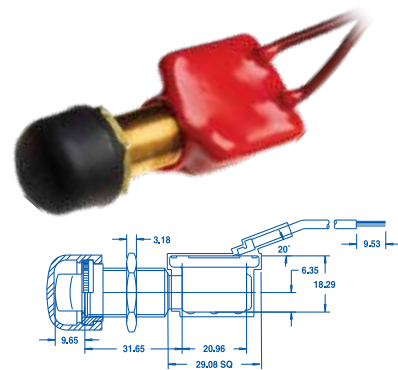

## SPST Off/On Sealed Push Button Switch

**M606BX**

### Features

- Pre-wired PVC coated housing
- Chrome plated brass knob and face nut
- Copper alloy contacts, dia 22.3mm
- Suits panel thickness up to 15.87mm

### Specifications

- Voltage . . . . . 6V-36V Multivoltage
- Amperage . . . . . 10A@12V, 5A@24V
- Dimensions . . . H 82 x D 22 x W 32

### Part Numbers

M606BX . . . . . Boxed



## SPST Off/On Screw Push Pull Button Switch

**M628BX**

### Features

- 2 Screw terminals, Brass Push Pull
- Copper alloy contacts, dia 22.3mm
- Chrome plated brass knob and face nut
- Suits panel thickness up to 15.87mm

### Specifications

- Voltage . . . . . 6V-36V Multivoltage
- Amperage . . . . . 10A@12V, 5A@24V
- Dimensions . . . . . H 68 x D 22 x W 31

### Part Numbers

M628BX . . . . . Boxed



## SPST Off/Mom On Screw Push Button Switch

**M485BX**

### Features

- Spring return to OFF
- 2 Screw terminals, silver contacts
- Brass case, stem, plunger button, terminals
- Gasket sealed case
- Stem 5/8"-32, L 35mm, panel to 19mm

### Specifications

- Voltage . . . . . 6V-36V Multivoltage
- Amperage . . . . . 10A@12V, 5A@24V
- Dimensions . . . . . H 39 x D 67 x W 29

### Part Numbers

M485BX . . . . . Boxed

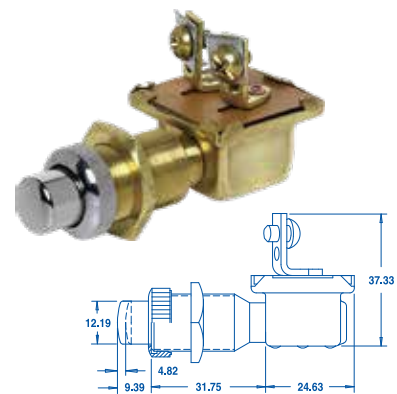

## SPDT Off/On/On Push Pull Button Switch

**M532BX**

### Features

- Copper alloy contacts
- 4 screw terminals, Dia 22.3mm
- Off- On 1&2, On- On 1&3
- Chrome plated knob & face nut
- Suits panel thickness up to 15.87mm

### Specifications

- Voltage . . . . . 6V-36V Multivoltage
- Amperage . . . . . 10A@12V, 5A@24V
- Dimensions . . . . . H 97 x D 35 x W 29

### Part Numbers

M532BX . . . . . Boxed

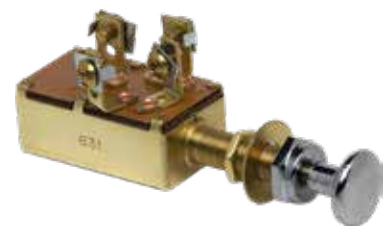

## SPST On/Mom Off Screw Push Button Switch

**9115BX**

### Features

- Spring return to ON
- Normally ON, chrome button
- 2 screw terminals (with lock washers)
- Stem 5/8"-32, L 22.3mm, Dia 16mm
- Suits panel thickness 12.7mm

### Specifications

- Voltage . . . . . 6V-36V Multivoltage
- Amperage . . . . . 10A@12V, 5A@24V
- Dimensions . . . . . H 33 x D 51 x W 23

### Part Numbers

9115BX . . . . . Boxed

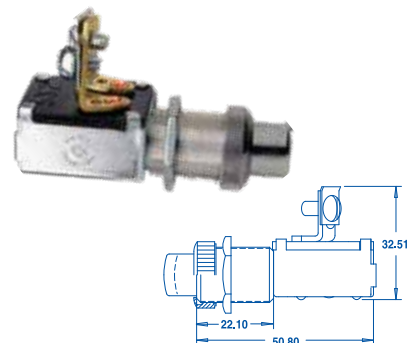

## SPST Off/Mom On Screw Push Button Switch

**9011BX**

### Features

- Spring return to OFF
- 2 Screw terminals, compact design
- Aluminium stem: L 9.52mm, Dia 22.3mm
- Suits panel thickness 6.35mm

### Specifications

- Voltage . . . . . 6V-36V Multivoltage
- Amperage . . . . . 5A@12V, 2.5A@24V
- Dimensions . . . . . H 33 x Ø 33

### Part Numbers

9011BX. . . . . Boxed

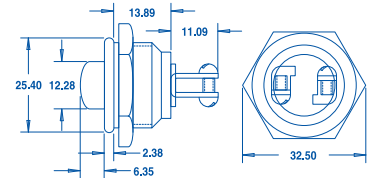

## SPST Off/Mom On Screw Push Button Switch

**9095BX**

### Features

- Spring return to OFF
- 2 Screw terminals, silver contacts
- Mounting stem 5/8-32", Length 16mm
- Suits panel thickness 6.35mm -16mm

### Specifications

- Voltage . . . . . 6V-36V Multivoltage
- Amperage . . . . . 35A@12V, 20A@24V
- Dimensions . . . . . H 58 x Ø 28

### Part Numbers

9095BX. . . . . Boxed

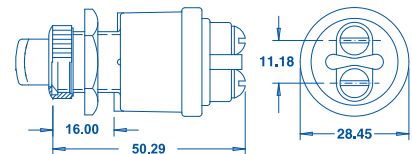

## SPST Off/Mom On Push Button Switch

**96101BX**

### Features

- Spring return to OFF
- 2 screw terminals
- Copper alloy contacts
- Black button, flange mount

### Specifications

- Voltage . . . . . 6V-36V Multivoltage
- Amperage . . . . . 10A@12V, 5A@24V
- Dimensions . . . . . H 56 x D 26 x W 30

### Part Numbers

96101 BX. . . . . Boxed

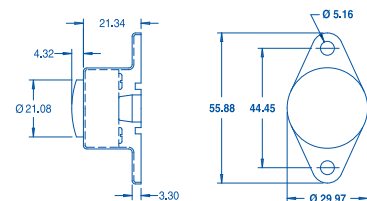

## Rotary Switches

Rotary switches are usually used for special purpose applications including headlamp and windscreen wiper operation. The Cole Hersee range features models which can be used for more common applications.



### Headlamp Rotary Switch Off/On/On/On

**72079-01BX**

#### Features

- Black actuator knob, Headlamp symbol
- Positions: Hazard, Head & Tail light, Dash & Work light
- Silver contacts, 5 screw terminals
- O-ring Mounting stem 5/8"-32 thread

#### Specifications

- Voltage . . . . 6V-24V Multivoltage
- Amperage . . . . 20A@12V, 10A@24V
- Dimensions . . H 80 x Ø 53

#### Part Numbers

72079-01BX . . . . Boxed

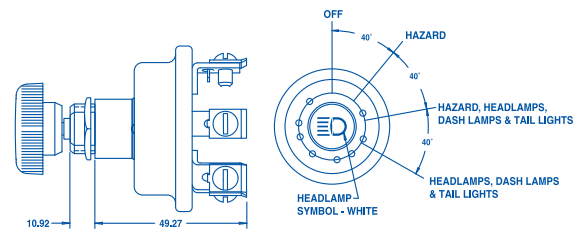

### Rheostat Dimmer Off/Variable Switch

**7496-11BX**

#### Features

- Black actuator, 2 blade terminals
- Ceramic insulator with embedded coil
- Mounting stem 7/16"-28 thread
- Mounting stem length 10.34mm

#### Specifications

- Voltage . . . . 12V
- Amperage . . . . 2.1A@12V, 18 Ohms
- Dimensions . . H 58 x Ø 34

#### Part Numbers

7496-11BX . . . . Boxed

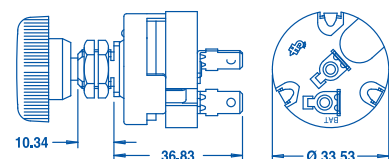

## Windscreen Wiper Washer Off/Park/Lo/Hi

75221-09BX

### Features

- Without dynamic parking
- 5 blade terminals
- 6A internal circuit breaker
- Push to wash, white imprint
- Mounting stem thread 7/16"-28
- Mounting stem length 9.6mm

### Specifications

- Voltage . . . . 12/24V Dualvoltage
- Amperage . . . . 6A@12V, 3A@24V
- Dimensions . . . H 61 x Ø 41

### Part Numbers

75221-09BX . . . . Boxed



## Windscreen Wiper Washer Off/Park/Lo/Hi

75228-03BX

### Features

- For dynamic parking motors, single motor
- 6 blade terminals
- Push to wash, white imprint
- O-ring sealed shaft
- Mounting stem 7/16"-28 thread
- Mounting stem length 11.43mm

### Specifications

- Voltage . . . . 12/24V Dualvoltage
- Amperage . . . . 6A@12V, 3A@24V
- Dimensions . . . H 61 x D 41

### Part Numbers

75228-03BX . . . . Boxed

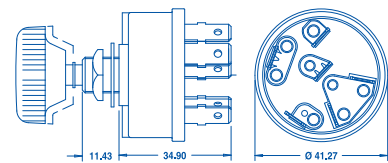

## DPDT Reversing Mom On/Off/Mom On

75712-04BX

Heavy duty 50A switch allows forward and reverse motion of a motor without the need for a relay, especially for operation of tarps on trucks.

### Features

- 4 Screw terminals, silver contacts
- Mounting stem 1/2"-20
- Terminal screws 10-32 / 9.5mm
- Forward and reverse control of motors

### Specifications

- Voltage . . . . 6V-36V Multivoltage
- Amperage . . . . 50A@12V, 30A@24V
- Dimensions . . . H 69 x Ø 53

### Part Numbers

75712-04BX . . . . Boxed

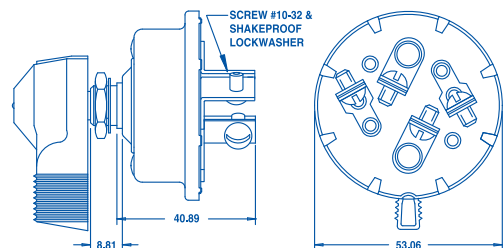
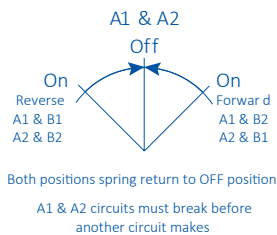

## SPST Off/On Round Knob Rotary Switch

72150-01BX

### Features

- Compact durable nylon body, knob and stem, IP53
- Aluminium hardware, plated brass blade terminals
- Dimensions H 30 x D 52 x W 30

### Specifications

- Voltage . . . . 6V-24V Multivoltage
- Amperage . . . . 10A@12V, 5A@24V

### Part Numbers

72150-01BX . . . . Boxed



## SPDT Off/On/On Round Knob Rotary Switch

72171-02BX

### Features

- Compact durable nylon body, knob and stem, IP53
- Aluminium hardware, plated brass blade terminals
- Dimensions H 30 x D 52 x W 30

### Specifications

- Voltage . . . . 6V-24V Multivoltage
- Amperage . . . . 10A@12V, 5A@24V

### Part Numbers

72171-02BX . . . . Boxed



## SPST Off/On Flat Knob Rotary Switch

72150-02BX

### Features

- Compact durable nylon body, knob and stem, IP53
- Aluminium hardware, plated brass blade terminals
- Dimensions H 30 x D 55 x W 30

### Specifications

- Voltage . . . . 6V-24V Multivoltage
- Amperage . . . . 10A@12V, 5A@24V

### Part Numbers

72150-02BX . . . . Boxed



## SPDT Off/On/On Flat Knob Rotary Switch

72171-04BX

### Features

- Compact durable nylon body, knob and stem, IP53
- Aluminium hardware, plated brass blade terminals
- Dimensions H 30 x D 55 x W 30

### Specifications

- Voltage . . . . 6V-24V Multivoltage
- Amperage . . . . 10A@12V, 5A@24V

### Part Numbers

72171-04BX . . . . Boxed



## SPDT Off/On/On Flat Red Knob Rotary Switch

72161-01BX

### Features

- Illuminated Red handle, 12V Standard
- Compact durable nylon body, knob and stem, IP53
- Aluminium hardware, plated brass blade terminals
- Dimensions H 30 x D 55 x W 30

### Specifications

- Voltage . . . . 12V
- Amperage . . . . 10A@12V

### Part Numbers

72161-01BX . . . . Boxed



## Windscreen Wiper Washer Electronic 12V

**75600-02BX**

### Features

- Pre-wired single motor control
- Silver contacts, heavy duty
- Mounting stem 7/16"-28 thread, L 11.4mm
- Suits system with or without dynamic park
- Approvals; SAE J1455, J112a, J234

### Specifications

- Voltage . . . . . 12V
- Amperage . . . . . 6A@12V
- Dimensions . . . H 47 x D 56 x W 56

### Part Numbers

75600-02BX . . . . . Boxed

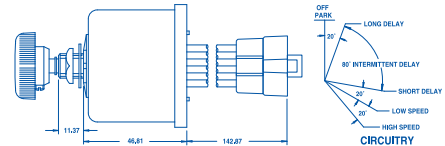

## Windscreen Wiper Washer Electronic 24V

**75602-04BX**

### Features

- Single motor control
- Silver contacts, heavy duty
- Mounting stem 7/16"-28 thread, L 11.4mm
- Suits system with or without dynamic park
- Variable speed intermittent function
- Approvals; SAE J1455, J112a, J234

### Specifications

- Voltage . . . . . 24V
- Amperage . . . . . 3A@24V
- Dimensions . . . H 47 x D 56 x W 56

### Part Numbers

75602-04BX . . . . . Boxed

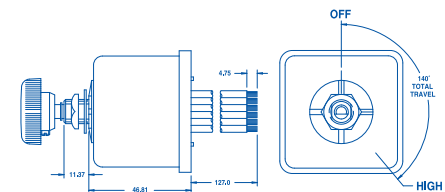

## Ignition Switches

Ignition switches are usually operated by a coded key and tumbler lock, hencol keyed lock or lever. Lever design is available in three different configurations: short, long and military. Ignition switches are available with coded cylinder locks and keys or hencol non-tumbler locks with compatible keys.

Switches are available with a grounded case design with a separate ground terminal. A grounded case switch must be installed in a metal panel which is part of the vehicle earthing system. In non-grounded panels, select a switch with an earth terminal.



For applications subject to adverse environmental conditions a switch can be furnished with an O-ring seal in the bushing and a gasket seal to protect the terminal insulator. As an added feature Cole Hersee manufacturers weather resistant rubber boot and mounting assemblies, and protective caps.

Two, three and four position circuitry is available for battery ignition and magneto switches. Combination circuits include: earth, accessory, lighting, diesel glow plug, and anti-restart options. Standard configurations include spring return from one or two positions.

Screw terminals are equipped with lockwashers to assure efficient connection of circuit wire. Blade terminals are brass, 1/4" wide arranged to accept multi-pole connectors.

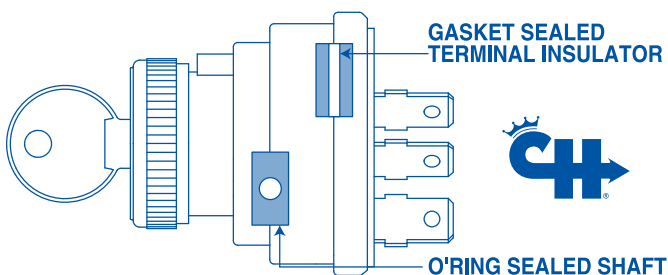

Key removable in OFF position only, spring return to IGN/ACC position.

### 4 POSITION

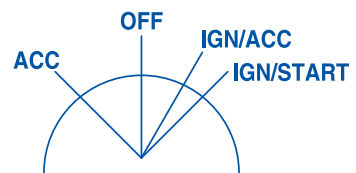

Key removable in OFF position only, spring return to IGN/ACC position, spring return to OFF from FUEL.

### 4 POSITION

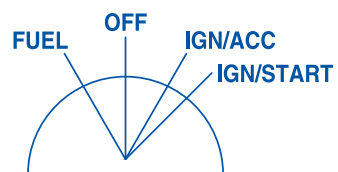

Key removable in OFF position only, spring return to IGN position.

### 3 POSITION

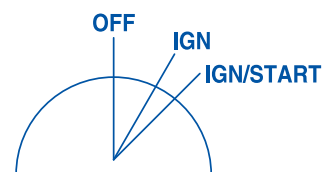

Spring return to OFF position from GLOW and GLOW/START.

### 3 POSITION

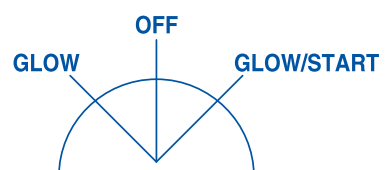



## Anti-restart 4 Position Sealed Ignition Switch

**95060-01BX**

This sealed switch from Cole Hersee is constructed from engineered thermoplastic and is OEM quality.

A fully sealed O-ring, ultrasonic welding and integral Deutsch connector, this switch is rated to IP67. Supplied with two matching keys including integrated boots.

### Features

- Engineered thermoplastic, OEM quality
- Fully sealed O-ring, ultrasonic welding
- Integral Deutsch connector, IP67
- Selectable switching and key options
- Multiple key codes or keyed alike option
- Supplied with 2 matching keys
- Plastic facenut and nickel plated back nut
- Key removable only in OFF position
- Spring return to IGN/ACC position
- Ideal for agricultural, earthmoving and mining

### Specifications

- Voltage . . . . . 6V-24V Multivoltage
- Amperage . . . . . 10A@12V, 5A@24V
- Dimensions . . . . . H 72 x Ø 51
- Modes . . . . . Acc/Off/Ign/Start (anti-restart)
- Application . . . . . Heavy Duty, Mining, Marine, Key Start

### Part Numbers

95060-01BX . . . . . Boxed

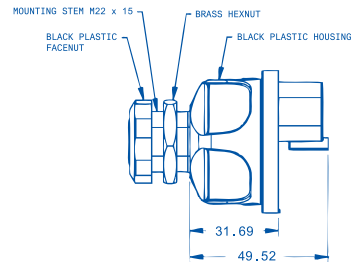
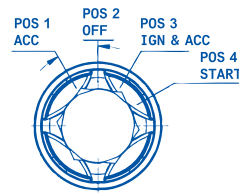

## 4 Position Heavy Duty Ignition Switch

**9579BX**

### Features

- 4 Screw terminals, bronze contacts
- Heavy duty, coded key actuator
- Key removable in OFF position only
- Mounting stem 3/4" – 20 bush
- Panel thickness 1.52mm to 9.52mm

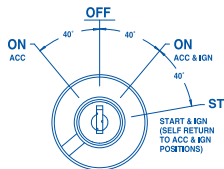

### Specifications

- Voltage . . . . . 12V
- Amperage . . . . . 10A@12V accessory, 10A@12V ignition, 10A@12V start
- Dimensions . . . . . H 60 x Ø 37
- Modes . . . . . Acc/Off/Ign Acc/Ign
- Application . . . . . Heavy Duty, Mining, Key Start

### Part Numbers

9579BX. . . . . Boxed



## Marine 3 Position Ignition Off/Ign/Ign Start

**M850BX**

### Features

- Push for choke, coded key actuator
- Impact resistant plastic body
- 3 Screw terminals, nickel silver contacts
- Individual key codes for added security
- Long stem suits panel up to 33mm thick

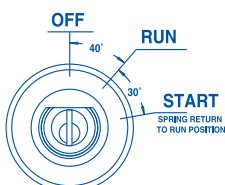

### Specifications

- Voltage . . . . . 6V-36V Multivoltage
- Amperage . . . . . 15A@6-36V ignition, 20A@6-36V start
- Dimensions . . . . . H 72 x Ø 38

### Part Numbers

M850BX . . . . . Boxed



## Marine 4 Position Ignition Acc/Off/Ign Start

**M712-02BX**



### Features

- O-ring sealed stem, cylinder shutter
- 4 Brass screw terminals, coded key actuator
- Brass contacts, case and hardware
- Key removable in OFF position only
- Mounting stem 13/16"-24 bush
- Mounting stem length 30.95mm
- Panel thickness up to 25.40mm

### Specifications

- Voltage . . . . . 12V
- Amperage . . . . . 10A@12V accessory, 10A@12V ignition, 5A@12V start
- Dimensions . . . . . H 74 x Ø 37

### Part Numbers

M712-02BX . . . . . Boxed

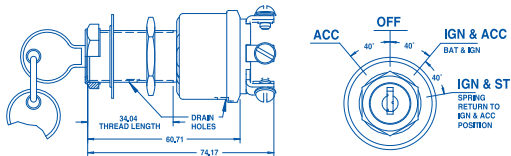

## Marine 3 Pos Ignition Switch Off/Ign/Ign Start

**M550BX**



### Features

- Heavy duty, 3 brass screw terminals
- Brass case and hardware, coded key actuator
- Key removable in OFF position only
- Mounting stem 13/16"-24 bush
- Mounting stem length 30.95mm
- Panel thickness up to 25.40mm

### Specifications

- Voltage . . . . . 12V
- Amperage . . . . . 10A@12V ignition, 5A@12V start
- Dimensions . . . . . H 74 x Ø 37

### Part Numbers

M550BX . . . . . Boxed

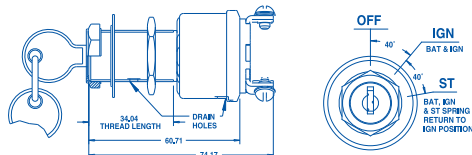

## Anti-restart Ignition Switch Off/On/Ign Start

**956-3125BX**

### Features

- 4 Screw terminals, Copper contacts
- O-ring sealed housing, keyed actuator
- Will not restart unless returned to OFF position
- Key removable in OFF position only
- Mounting stem 1"-24 bush
- Panel thickness 0.76mm to 2.85mm

### Specifications

- Voltage . . . . . 12V
- Amperage . . . . . 30A@12V accessory, 10A@12V ignition, 10A@12V start
- Dimensions . . . . . H 65 x Ø 47

### Part Numbers

956-3125BX . . . . . Boxed

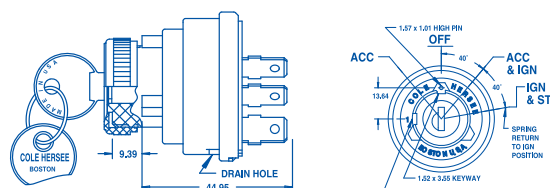

## Anti-restart Ignition Switch Off/Ign/Start

956-3124BX

### Features

- 4 Screw terminals, Copper contacts
- O-ring sealed housing, keyed actuator
- Will not restart unless returned to OFF position
- Mounting stem 1"-24 bush
- Panel thickness 0.76mm to 2.85mm

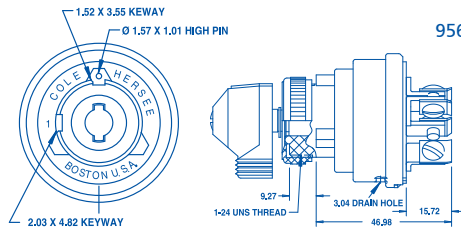

### Specifications

- Voltage . . . . 12V
- Amperage . . . 10A@12V accessory,  
10A@12V ignition,  
10A@12V start
- Dimensions . . H 78 x Ø 46

### Part Numbers

956-3124BX . . . . . Boxed



## Universal Ignition Switch Off/Ign/Start

95612BX

### Features

- 3 Screw terminals, silver contacts
- O-ring sealed housing, lever actuator
- Mounting stem 5/8-32
- Panel thickness 1.52mm to 6.65mm

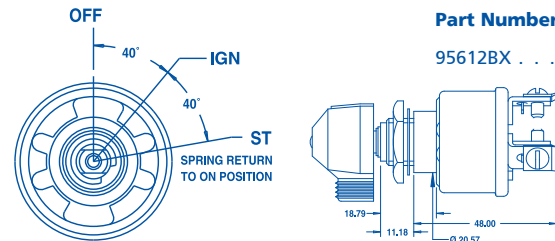

### Specifications

- Voltage . . . . 6V-36V Multivoltage
- Amperage . . . 25A@12V ignition,  
20A@12V start
- Dimensions . . H 81 x Ø 37

### Part Numbers

95612BX . . . . . Boxed



## Diesel Ignition Switch 3 Pos Glow/Off/Glow Start

95033BX

This heavy duty switch provides a superior pre-heat circuit to energize the glow pins.

### Features

- 3 Screw terminals, silver contacts
- O-ring sealed housing, Lever actuator
- Mounting stem 5/8-32
- Panel thickness 1.52mm to 6.65mm

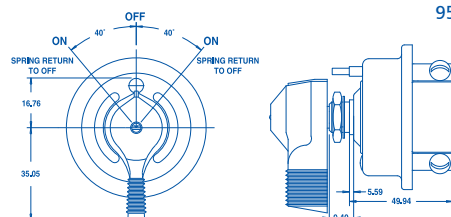

### Specifications

- Voltage . . . . 6V-36V Multivoltage
- Amperage . . . 50A@12V ignition,  
run glow,  
5A@12V start
- Dimensions . . H 81 x Ø 37

### Part Numbers

95033BX . . . . . Boxed



## Solenoids

A solenoid is an electromagnetic relay used in a direct current wiring system between a low current capacity switch and a high current load requirement. In an engine starting system, the ignition switch in the start position may have a rating of 5 amps whilst the starter motor may have a cranking requirement of 200 to 350 amps.

Once energised by the ignition switch, the solenoid coil moves the high current capacity contact to a closed position, thereby energising the starter motor.

When equipment is started, the intermittent starter application is used for only a few seconds during each start. To meet this short term demand, an intermittent solenoid is used to carry the high rating of current. However, the solenoid will overheat and fail, as would the starter motor, if the starter were to run continuously. For periods up to 15 seconds, it is constructed so it can be energised without overheating and destroying its windings.

Rated much lower, the continuous solenoid will not overheat in continuous operation. Used for such applications as accessory circuits and lifts—where there is uninterrupted operation—a continuous duty solenoid is constructed so it can be energised constantly without its windings.

As the demands placed upon vehicle electrical systems continue to increase, the electrical system components must be able to handle higher loads.

Numerous applications require a solenoid, listed below are just a few:

- Farm equipment
- Emergency vehicles
- Golf carts
- Hoists
- Buses
- Industrial equipment
- Construction equipment
- Tailgates
- Trucks
- Lift trucks
- Tractors



### Conservative Electrical Ratings for Solenoids

#### Intermittent Duty Solenoids

SPST 6–12 volts DC  
750 amp make  
100 amp break  
10 seconds ON, 20 minutes OFF

#### Intermittent Duty Solenoids

SPST 6–36 volts DC  
120 amp make  
65 amp break  
10 seconds ON, 30 minutes OFF

#### Continuous Duty Solenoids

SPST 24–36 volts DC  
85 amp make

#### Continuous Duty Solenoids: SPDT

35 amp: front studs, normally closed  
85 amp: side studs, normally open

### Cole Hersee Solenoids

- Intermittent Duty Solenoids: SPST, steel housing, normally open contacts, one circuit: OFF/ON
- Intermittent Duty Solenoids: SPST, phenolic housing, normally open contacts, one circuit: OFF/ON
- Intermittent Duty Solenoids: SPST, plasticised steel housing, normally open contacts, one circuit: OFF/ON
- Continuous Duty Solenoids: SPST, steel housing, normally open contacts, one circuit: OFF/ON
- Continuous Duty Solenoids: SPST, steel housing, normally closed contacts
- Continuous Duty Solenoids: SPST, steel housing, normally open and closed contacts
- Continuous Duty Solenoids: SPST, plasticised steel housing, normally open contacts, one circuit: OFF/ON
- Continuous Duty Latching Solenoids: carry only

Please note: some of the above mentioned options may not be shown in this catalogue.

## SPST Continuous Duty Solenoid Insulated Earth

**24059BX**

A solenoid in an electromagnetic relay used in a direct current wiring system between a low current capacity switch and a high current load requirement.

### Features

- 4 Stud, Insulated stud earth
- SPST Normally open (one circuit) OFF/ON
- Copper Stud terminals 5/16"-24
- Insulated Coil terminals 10-32
- Strong plated steel housing
- Plated steel nuts and washers included
- Mounting holes; 8mm x 15mm, 56mm CTC
- Mount with brand cap facing DOWN
- Int. ratings: 10 sec ON, 30 min OFF

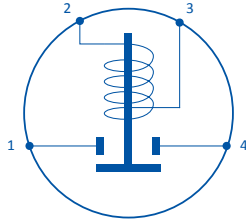

### Specifications

- Voltage . . . . . 12V, 24V, 36V Models
- Dimensions . . . H 60 x D 64 x W 84
- Configuration . SPST
- Modes . . . . . Off/On
- Application . . . Heavy Duty, Mining

### Part Numbers 12V, 17.5 ohm

- 24059BX . . . . . 85A Continuous  
750A Make  
100A Break
- 24143BX . . . . . 200A Continuous  
600A Inrush  
200A Make  
200A Break

### Part Numbers 24V, 71 ohm

- 24063BX . . . . . 85A Continuous  
120A Make  
100A Break
- 24144BX . . . . . 200A Continuous  
150A Make  
150A Break

### Part Numbers 36V, 130 ohm

- 24080BX . . . . . 85A Continuous  
120A Make  
65A Break

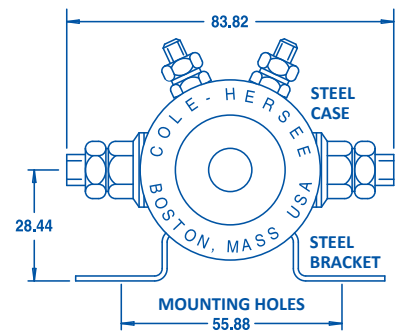

## SPST Continuous Duty Insulated Earth PVC Coated

**M24117BX**



A solenoid in an electromagnetic relay used in a direct current wiring system between a low current capacity switch and a high current load requirement.

Weatherproof PVC coated housing versions are UL listed and ISO 8846 Marine grade.

### Features

- 4 Stud, Insulated stud earth
- SPST Normally open (one circuit) OFF/ON
- Copper Stud terminals 5/16"-24
- Insulated Coil terminals 10-32
- Strong plated steel housing
- Plated steel nuts and washers included
- Mounting holes; 8mm x 15mm, 56mm CTC
- Mount with brand cap facing DOWN
- Int. ratings: 10 sec ON, 30 min OFF

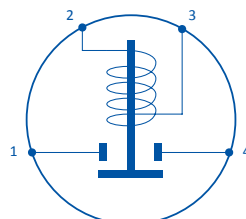

### Specifications

- Voltage . . . . . 12V, 24V, 36V Models
- Dimensions . . . H 60 x D 64 x W 84
- Configuration . SPST
- Modes . . . . . Off/On
- Application . . . Heavy Duty, Marine

### Part Numbers 12V, 17.5 ohm

- M24117BX . . . . . 85A Continuous  
750A Make  
100A Break

### Part Numbers 24V, 71 ohm

- 24063BX . . . . . 85A Continuous  
120A Make  
100A Break



## SPST Continuous 12V 110A Latching Solenoid

**24200BX**

### Features

- Pulse energise, stays on; pulse again, drops out.
- No heat generated due to coil taken out of circuit
- Copper Stud terminals 5/16"-24
- Insulated Coil terminals 10-32
- Strong plated steel housing
- Plated steel nuts and washers included
- Mounting holes 8mm x 15mm, 56mm CTC
- Mount with brand cap facing DOWN
- Int. ratings: 10 sec ON, 30 min OFF

### Specifications

- Voltage . . . . . 12V
- Dimensions . . . H 60 x D 79 x W 84
- Configuration . SPST
- Application . . . Heavy Duty, Mining

### Part Numbers

24200BX . . . . . 110A Continuous  
110A (carry only)

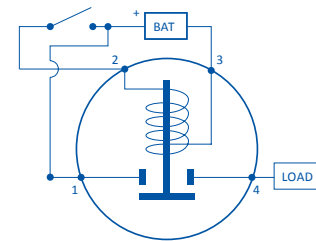

This special solenoid toggles On and Off, and requires no current to maintain the continuity of the power circuit. Use it with a Mom function switch. Actuation of the momentary switch causes current to flow in the solenoid coil, locking the contact in place, maintaining the load circuit in an On position. A second actuation of the momentary switch releases the plunger, turning the load circuit Off.

Suggested to be used with momentary switches.

### Remote Battery Isolator

In a two-battery system, use the Latching Solenoid to isolate the batteries from each other, and prevent battery drain from the higher into the lower. It has an advantage over electronic Battery Isolators, in that it will not produce a voltage drop during operation.

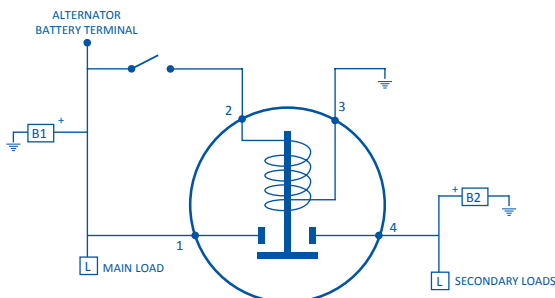

### Remote Battery Disconnect

Use it as a remote Battery Disconnect Switch. This eliminates the need for heavy gauge wiring between the control panel and the battery.

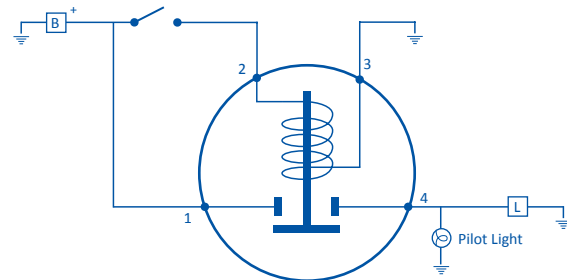

## SPST Intermittent Duty Solenoid Grounded Earth

**24037BX**

### Features

- 3 Stud, Grounded stud earth
- SPST Normally open (one circuit) OFF/ON
- Copper Stud terminals 5/16"-24
- Internal grounded, Coil terminals 10-32
- Strong plated steel housing
- Plated steel nuts and washers included
- Mounting holes; 8mm x 15mm, 56mm CTC
- Mount with brand cap facing DOWN
- Int. ratings: 10 sec ON, 20 min OFF

### Specifications

- Voltage . . . . . 12V, 24V, 36V Models
- Dimensions . . . H 60 x D 64 x W 84
- Configuration . SPST
- Modes . . . . . Off/On
- Application . . . Heavy Duty, Mining

### Part Numbers 12V, 4.4 ohm

24037BX . . . . . 750A Make  
100A Break

### Part Numbers 24V, 29 ohm

24063BX . . . . . 375A Make  
100A Break

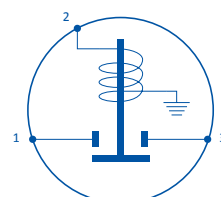

## SPST Intermittent Duty Solenoid Insulated Earth

**24047BX**

A solenoid in an electromagnetic relay used in a direct current wiring system between a low current capacity switch and a high current load requirement.

### Features

- 4 Stud, Insulated stud earth
- SPST Normally open (one circuit) OFF/ON
- Copper Stud terminals 5/16"-24
- Insulated Coil terminals 10-32
- Strong plated steel housing
- Plated steel nuts and washers included
- Mounting holes; 8mm x 15mm, 56mm CTC
- Mount with brand cap facing DOWN
- Int. ratings: 10 sec ON, 20 min OFF

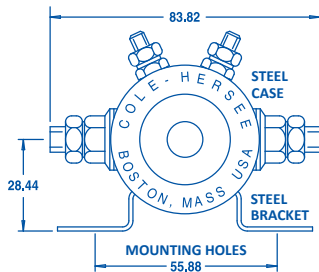

### Specifications

- Voltage . . . . . 12V or 24V Models
- Dimensions . . . H 60 x D 64 x W 84
- Configuration . SPST
- Modes . . . . . Off/On
- Application . . . Heavy Duty, Mining

### Part Numbers 12V, 4.4 ohm

24047BX . . . . . 750A Make  
100A Break

M200BX . . . . . 750A Make  
100A Break  
clear protective coating

### Part Numbers 24V, 29 ohm

24008BX . . . . . 120A Make  
65A Break

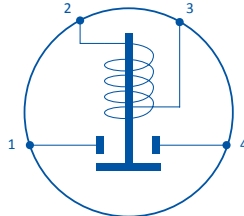

Marine, clear protective coating finish, M200BX

## DPDT Twin Motor Reversing Intermittent Solenoid

**24450BX**

For reversing motors such as hoists, winches, ATVs and snowplow blades.

Two solenoids in one for cost and space savings and simpler wiring. Two integral solenoids provide dynamic braking for permanent magnet motors when neither coil is energized.

### Features

- F bracket, copper contacts
- Coil terminal blades, common ground
- Two blade coil terminals 5/16"-24
- Black nylon housing, nuts & washers
- Strong black nylon housing
- Plated steel nuts and washers included
- Mounting holes, 105mm CTC

### Specifications

- Voltage . . . . . 12V, 24V Models
- Amperage . . . . . 75A@12V, 45A@24V
- Dimensions . . . H 76 x D 83 x W 127
- Configuration . DPST
- Modes . . . . . Intermittent Duty

### Part Numbers 12V

24450BX . . . . . Boxed

### Part Numbers 24V

24450-02BX . . . . . Boxed

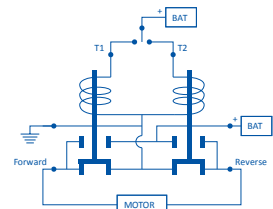
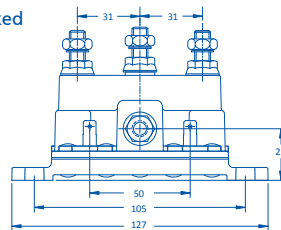

## DPST Two Circuit Change Over Solenoid

24401BX

This solenoid can be used for special application like forward and reverse systems in electric golf carts, garden tractors, fork lift trucks, winches, etc.

### Features

- Normally open and normally closed contacts
- Used for forward and reverse systems like winches, fork lifts, etc
- Copper Stud terminals 5/16"-24
- Insulated Coil terminals 10-32
- Strong plated steel housing
- Plated steel nuts and washers included
- Mounting holes; 8mm x 15mm, 56mm CTC
- Int. ratings: 10 sec ON, 30 min OFF

### Specifications

- Voltage . . . . . 12V, 24V Models
- Amperage . . . . . 35A Normally Closed, 85A Normally Open Continuous
- Dimensions . . . H 60 x D 64 x W 84
- Configuration . DPST
- Modes . . . . . Continuous Duty
- Application . . . Heavy Duty, Mining

### Part Numbers 12V, 17.5 ohm

24401BX . . . . . Boxed

### Part Numbers 24V, 71 ohm

24402BX . . . . . Boxed

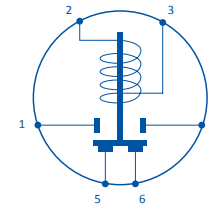
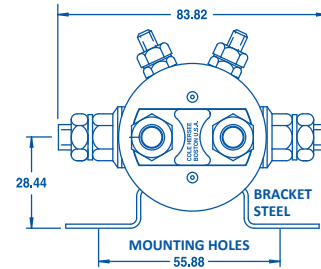

### Motor Reversing Solenoid Wiring Diagram

Typical DC series wound permanent magnet circuit, using a pair of double-action solenoids. Use pairs of the following solenoids: 24401 (12V) or 24402 (24V).

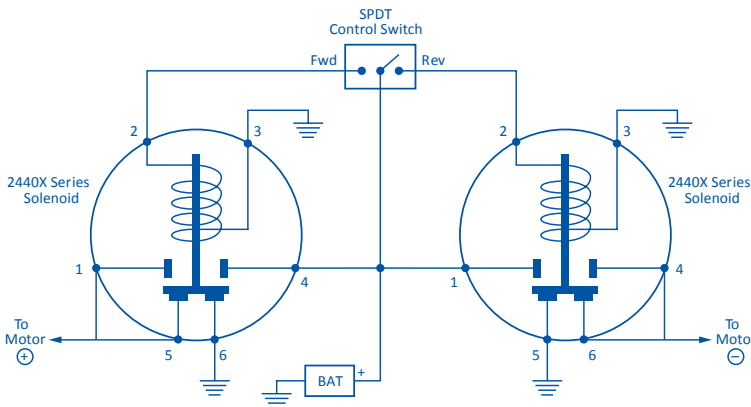

## Twin Motor Forward & Reverse Relay Solenoid

24452BX

### Features

- Dynamic braking when switch turned OFF
- Heavy load current, dielectric strength 500V RMS
- Studs are securely protected in epoxy
- Low profile module (less than H 50mm)
- Fully sealed for harsh environment,
- Rust and moisture resistant housing
- Tin plated brass studs, vibration resistance: 10-55Hz
- For intermittent operation use switch: Mom On/Off/Mom On
- For continuous use switch: On/Off/On
- Ideal for tarp, hoist, winch, fans and other motor reversing applications
- Automatically reverses the direction of motors

Reversing module carries a heavy load and is suitable for intermittent or continuous operation at 12V DC.

Ideal for tarp or lift applications as well as for hoists, hatches, winches/ windlasses, snowplows, intake/exhaust fans, vehicle outriggers and many other direction reversing applications.

### Specifications

- Voltage . . . . . 12V
- Dimensions . . . H 48 x D 74 x W 92
- Configuration . SPST
- Modes . . . . . Off/On
- Application . . . Heavy Duty, Mining

### Part Numbers 12V

24452BX . . . . . Boxed

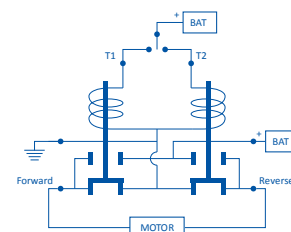



## SPST 225A Heavy Duty Solenoid Continuous

**24812BX**

For use with heavy vehicles, materials handling, hydraulic systems, large DC machinery, and electric vehicles.

### Features

- SPST Normally open (one circuit) OFF/ON
- Copper Stud terminals 5/16"-24
- Insulated Coil terminals 10-32, L bracket
- Strong plated steel housing
- Plated steel nuts and washers included
- Mounting holes 8mm x 15mm, 56mm CTC
- Int. ratings: 10 sec ON, 30 min OFF

### Specifications

- Voltage . . . . . 12V, 24V Models
- Dimensions . . . H 103 x D 69 x W 100
- Configuration . . SPST
- Modes . . . . . Continuous Duty
- Application . . . Heavy Duty

### Part Numbers 12V, 7.7 ohm

24812BX . . . . . 225A Continuous  
750A Make  
150A Break

### Part Numbers 24V, 32 ohm

24824BX . . . . . 225A Continuous  
250A Make  
150A Break

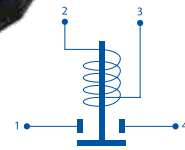

## SPST 12V 100A Continuous Nylon Solenoid

**24612-10BX**

### Features

- SPST Normally open (one circuit) OFF/ON
- 4 Stud, Copper Stud terminals 5/16"-24
- Insulated coil terminal 10-32
- Glass black nylon housing, F bracket
- Plated steel nuts and washers included
- Mounting holes 8mm x 15mm, 56mm CTC
- Int. ratings: 10 sec ON, 30 min OFF

### Specifications

- Voltage . . . . . 24V
- Amperage . . . . . 100A Continuous  
400A Inrush  
100A Make and Break
- Dimensions . . . H 65 x D 47 x W 76

### Part Numbers

24612-10BX . . . 12V, 16 ohm

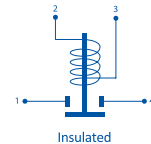
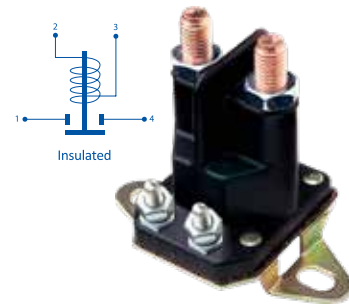

## SPST 24V 100A Continuous Nylon Solenoid

**24624-10BX**

### Features

- SPST Normally open (one circuit) OFF/ON
- 4 Stud, Copper Stud terminals 5/16"-24
- Insulated coil terminal 10-32
- Glass black nylon housing, F bracket
- Plated steel nuts and washers included
- Mounting holes 8mm x 15mm, 56mm CTC
- Int. ratings: 10 sec ON, 30 min OFF

### Specifications

- Voltage . . . . . 24V
- Amperage . . . . . 100A Continuous  
200A Inrush  
100A Make and Break
- Dimensions . . . H 65 x D 47 x W 76

### Part Numbers

24624-10BX . . . 24V, 64 ohm

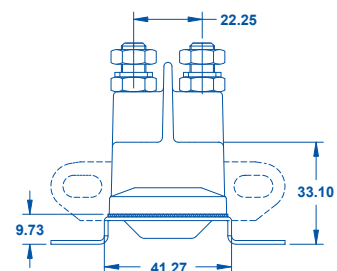
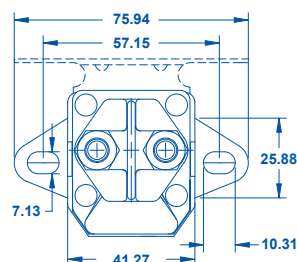
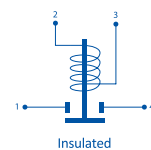
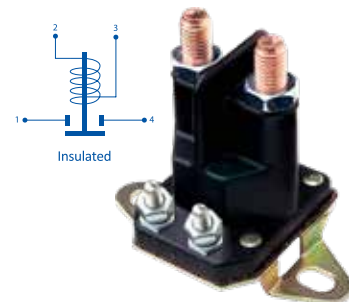

## SPST 12V 100A Continuous Nylon Solenoid

24612-G10BX

### Features

- 3 Stud, Grounded stud earth, F bracket
- SPST Normally open (one circuit) OFF/ON
- Copper Stud terminals 5/16"-24
- Internal grounded coil terminal 10-32
- Plated steel nuts and washers included
- Mounting holes 8mm x 15mm, 56mm CTC
- Int. ratings: 10 sec ON, 30 min OFF

### Specifications

- Voltage . . . . . 12V
- Amperage . . . . . 100A Continuous  
100A Make and Break
- Dimensions . . . H 65 x D 47 x W 76

### Part Numbers 12V, 16 ohm

24612-G10BX . . . Boxed

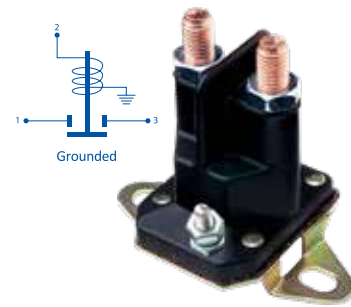

## SPST 12V 100A Continuous Nylon Solenoid

24512-10BX

### Features

- SPST Normally open (one circuit) OFF/ON
- 2 Blade, 2 Stud, Copper Stud terminals 5/16"-24
- Insulated coil terminal 10-32
- Glass black nylon housing, F bracket
- Plated steel nuts and washers included
- Mounting holes 8mm x 15mm, 56mm CTC
- Int. ratings: 10 sec ON, 30 min OFF

### Specifications

- Voltage . . . . . 12V
- Amperage . . . . . 100A Continuous  
400A Inrush  
100A Make and Break
- Dimensions . . . H 65 x D 47 x W 76

### Part Numbers 12V, 16 ohm

24512-10BX . . . . . Boxed

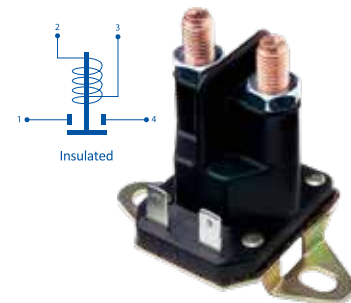

## SPST 12V 100A Continuous Nylon Solenoid

24612BX

### Features

- SPST Normally open (one circuit) OFF/ON
- 4 Stud, Copper Stud terminals 5/16"-24
- Insulated coil terminal 10-32
- Glass black nylon housing, L bracket
- Plated steel nuts and washers included
- Mounting holes 8mm x 15mm, 56mm CTC
- Int. ratings: 10 sec ON, 30 min OFF

### Specifications

- Voltage . . . . . 12V
- 24059BX . . . . . 100A Continuous  
400A Inrush  
100A Make and Break
- Dimensions . . . H 65 x D 47 x W 76

### Part Numbers 12V, 16 ohm

24612BX . . . . . Boxed

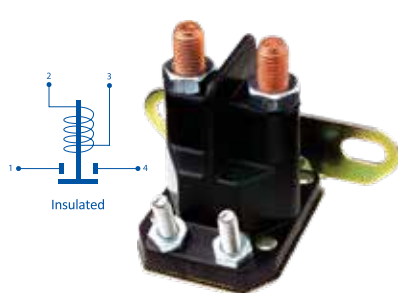

## SPST 12V 200A Intermittent Nylon Solenoid

24712-GS7BX

### Features

- 3 Stud, Grounded stud earth, F bracket
- SPST Normally open (one circuit) OFF/ON
- Copper Stud terminals 5/16"-24
- Internal grounded coil terminal 10-32
- Plated steel nuts and washers included
- Mounting holes 8mm x 15mm, 56mm CTC
- Int. ratings: 20 sec ON, 40 min OFF

### Specifications

- Voltage . . . . . 12V
- Amperage . . . . . 200A Intermittent  
500A Inrush  
200A Make and Break
- Dimensions . . . H 65 x D 47 x W 76

### Part Numbers 12V, 16 ohm

24712-GS7BX . . . Boxed

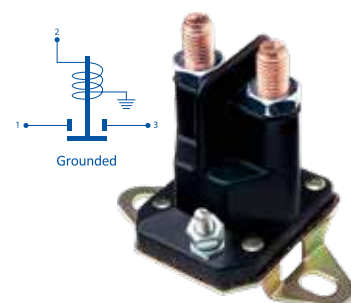

## SPST 12V 200A Intermittent Nylon Solenoid

24512-03BX

### Features

- SPST Normally open (one circuit) OFF/ON
- 2 Blade, 2 Stud, Copper Stud terminals 5/16"-24
- Insulated coil terminal 10-32
- Glass black nylon housing, L bracket
- Plated steel nuts and washers included
- Mounting holes 8mm x 15mm, 56mm CTC
- Int. ratings: 20 sec ON, 40 min OFF

### Specifications

- Voltage . . . . 12V
- Amperage . . . 200A Intermittent  
500A Inrush  
200A Make and Break
- Dimensions . . H 65 x D 47 x W 76

### Part Numbers 12V, 16 ohm

24512-03BX . . . Boxed

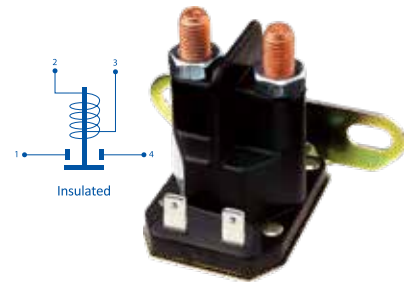

## SPST 12V 200A Intermittent Nylon Solenoid

24512-13BX

### Features

- SPST Normally open (one circuit) OFF/ON
- 2 Blade, 2 Stud, Copper Stud terminals 5/16"-24
- Insulated coil terminal 10-32
- Glass black nylon housing, F bracket
- Plated steel nuts and washers included
- Mounting holes 8mm x 15mm, 56mm CTC
- Int. ratings: 20 sec ON, 40 min OFF

### Specifications

- Voltage . . . . 12V
- Amperage . . . 200A Intermittent  
500A Inrush  
200A Make and Break
- Dimensions . . H 65 x D 47 x W 76

### Part Numbers 12V, 16 ohm

24512-13BX . . . Boxed

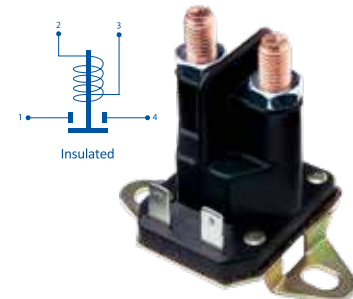

## SPST 12V 200A Intermittent Nylon Solenoid

24612-03BX

### Features

- SPST Normally open (one circuit) OFF/ON
- 4 Stud, Copper Stud terminals 5/16"-24
- Insulated coil terminal 10-32
- Glass black nylon housing, L bracket
- Plated steel nuts and washers included
- Mounting holes 8mm x 15mm, 56mm CTC
- Int. ratings: 20 sec ON, 40 min OFF

### Specifications

- Voltage . . . . 12V
- Amperage . . . 200A Intermittent  
500A Inrush  
200A Make and Break
- Dimensions . . H 65 x D 47 x W 76

### Part Numbers 12V, 16 ohm

24612-03BX . . . Boxed

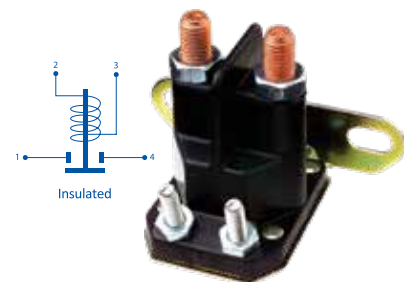

## SPST 12V 200A Intermittent Nylon Solenoid

24612-13BX

### Features

- SPST Normally open (one circuit) OFF/ON
- 2 Blade, 2 Stud, Copper Stud terminals 5/16"-24
- Insulated coil terminal 10-32
- Glass black nylon housing, F bracket
- Plated steel nuts and washers included
- Mounting holes 8mm x 15mm, 56mm CTC
- Int. ratings: 20 sec ON, 40 min OFF

### Specifications

- Voltage . . . . 12V
- Amperage . . . 200A Intermittent  
500A Inrush  
200A Make and Break
- Dimensions . . H 65 x D 47 x W 76

### Part Numbers 12V, 16 ohm

24612-13BX . . . Boxed

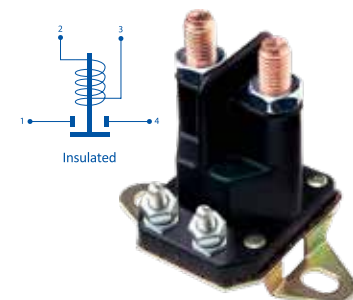

## Circuit Breakers

Cole Hersee circuit breakers and compatible mounting brackets are designed and engineered for responsive performance over a long period. Casings are manufactured from either high quality plated steel or durable plastic. Mounting brackets are available in heavy gauge steel or lightweight moulded plastic.

All electrical circuits need protection so an overload condition can be detected and the circuit opened until the overload can be corrected. The inexpensive protection of a circuit breaker can save the failure of an expensive piece of equipment or an even greater loss due to an electrical fire.

Generation of heat is a result of an electrical overload. A fuse has a metal element which is designed to melt and open the circuit at a relatively low heat. Two different elements of metals are used in a circuit breaker. The elements bend and separate due to heat, thus opening the circuit. A melted fuse must be replaced, but a circuit breaker can continue to function after the cause of the overload is corrected.



Most electrical systems have numerous circuits: each circuit can be operated independently, therefore each circuit needs protections. With direct current circuits in a battery powered vehicle, circuit protection is very important. The cost of an engine starter or other equipment in a car or truck compared to the cost of a circuit breaker, makes the circuit breaker an obvious and necessary addition.

Circuit breakers are the choice for protection in heavy duty vehicles and equipment. There are more than twenty types of circuit breakers to fit the requirements of both equipment design engineers and aftermarket replacement—suitable for vehicles on and off the road, equipment in the field and the construction site.

### SAE J553 Circuit Breaker Types

**Type I:** Automatic: Cycle or continuously reset until the overload is corrected

**Type II:** Remains open as long as the overload exists, the unit resets when the situation is corrected

**Type III:** Manual: Remains open until the unit is manually reset by pushing a button

### Circuit Breaker Type Options

#### Type I

- 12 volt, steel housing, bracket along case
- 12 volt, steel housing, snap-in mounting
- 12 volt, steel housing, plug-in mounting
- 24 volt, steel housing, bracket along case
- 24 volt, steel housing, snap-in mounting
- 12 volt, steel housing, dual circuit breaker, bracket along case
- 12 volt, plastic housing, bracket along case
- 12 volt, plasticised housing, no bracket
- 12 volt, plasticised housing, bracket along case

#### Type II

- 12 volt, steel housing, bracket along case
- 12 volt, steel housing, snap-in mounting
- 12 volt, plastic housing, plug-in mounting
- 12 volt, plastic housing, fuse clip snap-in mounting

#### Type III

- 12 volt, plastic housing, bracket along case
- 12 volt, plastic housing, snap-in mounting

Please note: some of the above mentioned options may not be shown in this catalogue.

### Metal or Plastic Body?

There's not a lot of difference between metal body and plastic body circuit breakers: both are about the same weight and structural integrity, but the plastic type is more resistant to denting and corrosion. One type of plastic-body breaker, the 30427 series, is also weather-resistant.

# SAE J553 For Circuit Breakers

Society of Automotive Engineers Standard J553 defines testing and performance requirements for three types of circuit breakers up to 50A for 6V, 12V, and 24V operation: Type I, Type II and Type III.

## Conforming circuit breakers

- Must carry 100% of rated current continuously for a minimum of 1 hour
- Must open at 135% of rated current within 30 minutes
- Must open at 200% of rated current within 1 minute

The specific current capacity of the circuit breaker is a function of the particular electrical system being utilised.

It is recommended that the actual performance be verified through testing experimentally in the proposed application.

Several factors should be considered:

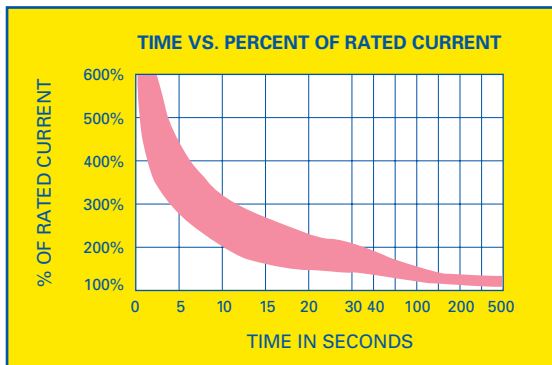

## Ambient temperature

Circuit breakers are thermal devices. Changes in the ambient temperature will have an effect on the current carrying capacity and on the effective limitation of current during overload cycling.

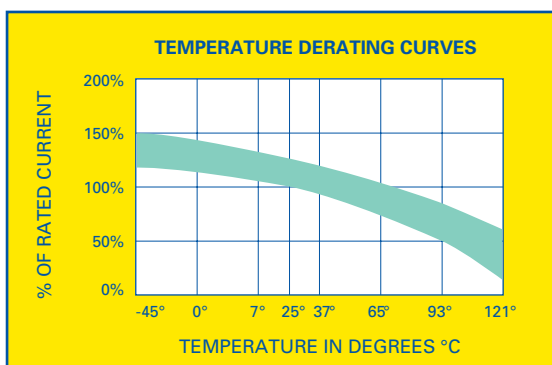

## Wire and Terminations

The connecting wires and their terminations will affect the heat dissipation characteristic of the breakers. Deviations from the breaker application specifications may affect the current carrying capacity or the effective limitation of current during overload cycling.

## Voltage Rating

The rating marked on breakers is the maximum value recommended. Use at higher voltages may significantly shorten product life under load conditions, and possibly cause damage to your equipment.

## Circuit Protection

Components are thermal devices that create an open circuit under overcurrent conditions. They are deliberately designed as the sacrificial weakest link in a system, protecting components from costly damage. It is important to select a fuse or circuit breaker with a current rating equal to or lower than the lowest current rating of any part of the circuit.

All Cole Hersee circuit breakers conform to SAE Standard J553.

## Metal Thermal Reset Cycling Circuit Breakers

30055-10BX

These metal Type I circuit breakers cycle or continuously reset until the overload is corrected.

### Features

- Plated steel case and mounting brackets
- Flange mount, stud terminals 10-32
- Short stud – BAT, Long stud – LOAD

### Specifications

- Voltage . . . . 12V, 24V
- Amperage . . . 6A, 10A, 15A, 20A, 25A, 30A, 40A, 50A
- Dimensions . . H 31 x D 20 x W 51

### Part Numbers 12V

30055-6BX . . . .	6A
30055-10BX . . . .	10A
30055-15BX . . . .	15A
30055-20BX . . . .	20A
30055-25BX . . . .	25A
30055-30BX . . . .	30A
30055-40BX . . . .	40A
30055-50BX . . . .	50A

### Part Numbers 24V

30172-10BX . . . .	10A
30172-15BX . . . .	15A
30172-20BX . . . .	20A
30172-30BX . . . .	30A



## Plastic Thermal Reset Cycling Circuit Breakers

30427-10BX

These weather resistant plastic Type I circuit breakers cycle or continuously resets until the overload is corrected.

### Features

- Weather resistant plastic body
- Grey plastic case and mounting brackets
- Flange mount, stud terminals 10-32
- Short stud – BAT, Long stud – LOAD
- Dimensions H 31 x D 20 x W 51

### Specifications

- Voltage . . . . 12V
- Amperage . . . 10A, 15A, 20A, 25A, 30A, 40A

### Part Numbers 12V

30427-10BX . . . .	10A
30427-15BX . . . .	15A
30427-20BX . . . .	20A
30427-25BX . . . .	25A
30427-30BX . . . .	30A
30427-40BX . . . .	40A



## Plastic Plug-in Cycling Mini Circuit Breakers

30418-10BX

These metal Type I circuit breakers cycle or continuously resets until the overload is corrected.

### Features

- Grey plastic housing, plug in mounting
- Dimensions H 27 x D 6 x W 11

### Specifications

- Amperage . . . 10A, 15A, 20A, 25A,

### Part Numbers 12V

30418-10BX . . . .	10A
30418-15BX . . . .	15A
30418-20BX . . . .	20A
30418-25BX . . . .	25A



## Metal Plugin Cycling ATC/ATO Circuit Breakers

**30409-10BX**

These metal Type I circuit breakers cycle or continuously resets until the overload is corrected.

Terminals are grooved so that they can be easily snapped off with pliers to fit the electrical blocks of different vehicles.

Use as is long terms for Kenworth trucks.

### Features

- Plated steel case, plug in mounting
- Cut on grooves for Length of terminals

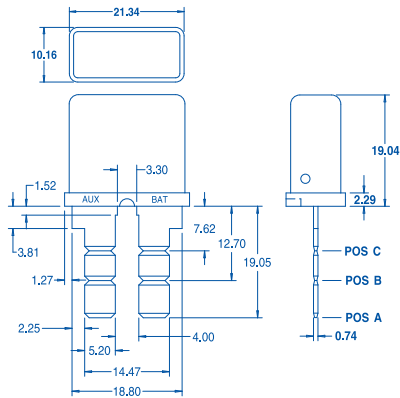

### Specifications

- Voltage . . . . . 12V
- Amperage . . . . . 10A, 15A, 20A, 25A, 30A
- Dimensions . . . H 19 x D 10 x W 21

### Part Numbers 12V

- 30409-10BX . . . . . 10A
- 30409-15BX . . . . . 15A
- 30409-20BX . . . . . 20A
- 30409-25BX . . . . . 25A
- 30409-30BX . . . . . 30A



## Plastic Resettable Circuit Breakers Type III

**30407-15BX**

These plastic Type III resettable circuit breakers remains open on overload until reset button depressed.

### Features

- Push button reset, plastic case
- Flange mount, stud terminals 10-32
- Short stud – BAT, Long stud – LOAD

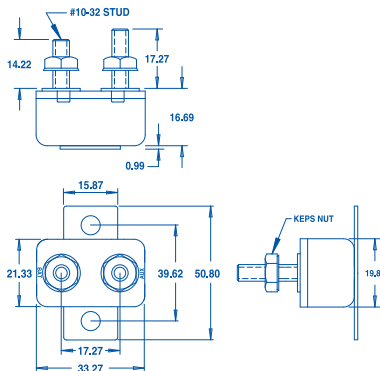

### Specifications

- Voltage . . . . . 12V
- Amperage . . . . . 10A, 15A, 20A, 25A, 30A, 40A
- Dimensions . . . H 31 x D 20 x W 51

### Part Numbers 12V

- 30407-15BX . . . . . 15A
- 30407-20BX . . . . . 20A
- 30407-25BX . . . . . 25A
- 30407-30BX . . . . . 30A
- 30407-40BX . . . . . 40A
- 30407-50BX . . . . . 50A





## Connectors and Electrical

The Cole Hersee range includes high quality connectors and electrical equipment such as heavy duty trailer connectors, battery studs and jumpers, headlight connectors and electronic units.

Cole Hersee trailer connectors are built to withstand the rigors of trucking thousands of kilometers in dust and dirt, heat and cold, yet maintain the all-important electrical continuity between vehicle and trailer.

### 7 Pole Trailer Connector Wiring

1	Earth return	White
2	Reversing lamp	Black
3	Left hand turn signal	Yellow
4	Stop lamps	Red
5	Right hand turn signal	Green
6	Rear, clearance, marker lamps	Brown
7	Service brakes	Blue

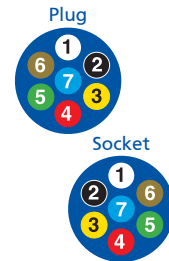

## 7 Pole Heavy Duty ABS Body Trailer Plug

**12311BX**

### Features

- Glass filled plastic housing prevents rust and corrosion
- Spring grip design with self-adjusting spring band for uniform contact with socket pins.
- Contacts flat for best alignment and connection
- O-ring at plug end prevents moisture from reaching contacts
- Strain relief isolates connections on terminals from mechanical strain.
- Grommet seal provides additional moisture protection

### Specifications

- Dimensions . . . H 40 x D 156 x W 76
- Approvals . . . ADR 42, SAE J560b

### Part Numbers

12311BX . . . . . Boxed

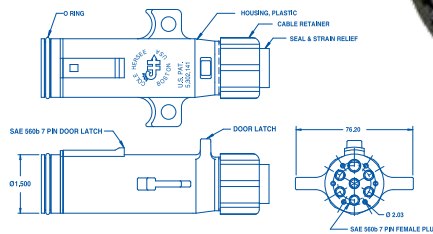

## 7 Pole Heavy Duty ABS Body Trailer Socket

**12080BX**

### Features

- Glass filled plastic housing prevents rust and corrosion
- Insulated circuit contacts (not self-grounding)
- Spring loaded cover
- Solid brass contact pins
- Earth Pin 8AWG others 10 AWG

### Specifications

- Dimensions . . . H 84 x D 54 x W 104
- Approvals . . . ADR 42, SAE J560b

### Part Numbers

12080BX . . . . . Boxed

12080-01BX . . . Split pin contacts

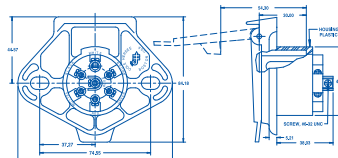







## Three Pole Sealed Beam Connector

**3028-02BX**

### Features

- Sealed beam connector without wires
- Three pole headlamp type
- High temperature resistant material with bronze contacts
- Pre-wired version available

### Specifications

- Dimensions . . . H 28 x D 16 x W 29

### Part Numbers

- 3028-02BX . . . . . Boxed
- 3029BX. . . . . Pre-wired



## Electronic Daytime Running Light Module

**48600BX**

This module automatically turns on low-beam headlights when the ignition is turned on (after a 10 second delay, thus reducing the initial starting load).

### Features

- Activated when the parking brake is released; deactivated when the parking brake is set (with ignition On)
- Deactivates when high beams are flashed for signaling
- DRLs on with ignition, 10 Sec delay
- Suits two or four headlamp systems
- 75% reduction of lamp intensity
- Suits positive switch circuits only
- Completely solid-state construction

### Specifications

- Voltage. . . . . 12V
- Dimensions . . . H 42 x D 75 x W 92

### Part Numbers

- 48600BX . . . . . Boxed

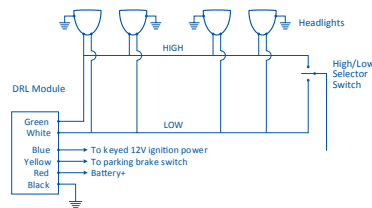

## Intermittent Duty Electronic Solenoid 9-31V

**48785BX**

### Features

- Fully solid state, fully sealed, resistant to vibration and adverse conditions
- Overcurrent and voltage spike protect
- No contacts, 20 million On-Off cycles
- Resistant to vibration, moisture and dust
- Operating temp -40° to 85° C
- Suitable for high inrush loads

### Specifications

- Amperage . . . 85A Continuous  
175A Intermittent  
2mA @12V draw
- Dimensions . . . H 76 x D 85 x W 135
- Application . . . Heavy Duty

### Part Numbers

- 48600BX . . . . . Boxed

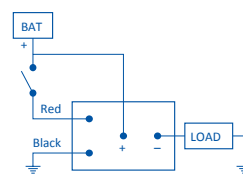

High side switching application

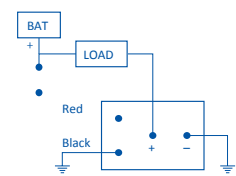

Low side switching application



## Website

In conjunction with Australian packaging, brochures and merchandising, ESG have developed a dedicated Australian Cole Hersee website.

- Browse and compare Cole Hersee products available in Australia
- Filter products to suit your application and requirements
- View the latest updates and additions to the range



[www.colehersee.com.au](http://www.colehersee.com.au)

## Partnership

ESG Asia Pacific are currently, and have been, the exclusive Australian distributor of Cole Hersee for over twenty years!

Along with Cole Hersee, ESG Asia Pacific also distributes other well-known automotive brands including ECCO, Code 3, Britax and Xray Vision.

ESG Asia Pacific is part of the ECCO Safety Group which globally serves more than 3,000 OEM and aftermarket customers.

# Cole Hersee

Edition 17.1

**ESG**<sup>®</sup>  
ECCO SAFETY GROUP



ESG Asia Pacific is part of the ECCO Safety Group of companies.

Britax is the registered trademark of, and is used under licence from, a member of the Britax group of companies.

**ESG Asia Pacific**  
Freecall 1800 025 921  
[www.eccosafetygroup.com.au](http://www.eccosafetygroup.com.au)